

Installation & Maintenance Instructions

# 104D RATE TOTALISER



Supplied by

**247able.com**

Call us on +44 (0)118 916 9420 | Email [info@247able.com](mailto:info@247able.com)

**FIELD MOUNTED  
RATE TOTALISER  
MODEL 104D**



March 2015



# CONTENTS

<b>1. Introduction</b>	<b>1</b>
<b>2. Specification</b>	<b>2</b>
<b>3. Operation</b>	<b>4</b>
3.1 Display	4
3.2 Test Mode	5
3.3 Filtering	6
3.4 Calculation of Rate and Total	7
3.5 Total Conversion	8
3.6 Frequency Cutoff	9
<b>4. Programming</b>	<b>10</b>
4.1 Program Steps	11
<b>5. Example</b>	<b>14</b>
<b>6. Outputs</b>	<b>15</b>
<b>7. Flowmeter Input</b>	<b>18</b>
<b>8. Installation</b>	<b>23</b>
8.1 Wall Mounting	23
8.2 Removing the Front Panel	24
8.3 The Main Electronics	26
8.4 Wiring	27
8.5 Terminal Designations	27
<b>Index</b>	<b>28</b>



# **1. INTRODUCTION**

The Model 104D Rate Totaliser is a microprocessor based instrument, Loop Powered with a 4-20mA output and Alarms. It accepts a frequency or pulse input from a wide range of flowmeters. The instrument displays flow Rate, a Resettable Total and an Accumulated Total directly in engineering units.

The instrument is compatible with a wide range of flowmeters including turbine, paddlewheel and positive displacement flowmeters.

The instrument is fully programmable from the front panel; the user can program scaling factors, decimal point positions, filter constants and timebase.

The Model 104D Rate Totaliser conforms to the EMC-Directive of the Council of European Communities 2004/108/EC, the LVD directive 2006/95/EC and the following standards:

*EN61326:2013*

Electrical equipment for measurement, control and laboratory use – EMC requirements : Residential, Commercial & Light Industry Environment & Industrial Environment.

*EN61010:2010*

Safety requirements for electrical equipment for measurement, control, and laboratory use.

In order to comply with these standards, the wiring instructions in Section 8.4 must be adhered to.

## 2 Specification

# 2. SPECIFICATION

### *General*

Display:	LCD which is continuously powered.
Resettable Total:	7 digits with 10mm (0.4") high digits. Resettable from front panel.
Accumulated Total:	Displayed when the ACCUM TOTAL button is pressed.
Rate:	4½ digits with 8.5mm (0.33") high digits.
K-factor:	The pulses per unit of measure (eg. pulses/gallon) is programmable in the range 0.000001 to 999,999.
Decimal Points:	Decimal point positions are fully programmable for both rate and total.
Timebase:	Rate can be displayed in units per second, minute, hour or day.
Frequency Range:	0.01Hz to 10kHz.
Signal Type:	Link settable for sinewave (15mV P-P minimum), open collector, reed switch, pulse or Namur proximity switch.
Scale:	The 4mA and 20mA points are programmable.
Resolution and Linearity:	0.05% of span.
Accuracy:	0.05% of span at 25°C. 0.1% (typ) of span, full temperature range.
Update Time:	0.5 second.
Connection:	Two-wire.
Loop Power Supply:	9-28 Volts.
Supply Backup:	2 x User replaceable Lithium battery.
Outputs:	Two open collector outputs suitable for driving DC solenoids or external relays. The outputs can be programmed to provide high and low flow alarms or pulse output and low flow alarm.
Switching Power:	750mA. 30VDC maximum.

Pulse Duration: 1ms if CALO = 2 (unscaled pulse output).  
If CALO = 1 (scaled pulse output) the duration of the pulse automatically adjusts to the output frequency:

- a. 1ms if output > 50Hz.
- b. 10ms if output = 5...50Hz.
- c. 100ms if output < 5Hz.

### ***Physical***

Temperature: Operating temperature: -20°C to 60°C.  
Dimensions: 97mm (3.8") high x 150mm (5.9") wide x 41mm (1.6") deep (cable glands not included).  
Protection: Sealed to Nema 4X or IP67 standards.  
Cable Entry: By cable glands.  
Wall Mounting: Universal mounting bracket supplied as standard.  
Pipe Mounting: A galvanised metal bracket is available which enables the Model 104D to be attached to a 2" vertical or horizontal pipe.  
Turbine Meter Adaptor: An optional mounting stem is available for mounting the Model 104D directly on turbine flowmeters which have a 1" NPT boss or 1" BSP boss.



## 4 Operation

# 3. OPERATION

The Model 104D Rate Totaliser accepts a frequency or pulse input from a wide range of flowmeters. The instrument is fully programmable with all operating parameters and calculation constants programmable from the front panel. The setup parameters are stored in a non-volatile memory and are retained for at least 10 years in the event of a power loss.

### 3.1 DISPLAY

The Model 104D displays:

*Rate*  
*Resettable Total*  
*Accumulated Total*

Both the Rate and Resettable Total are displayed continuously. The Accumulated Total is displayed only when the ACCUM TOTAL key is pressed.

The keys on the front of the 104D have the following functions:



Pressing this key will display the Accumulated Total.



This key resets the Resettable Total at any time.



This key is used during the Program Mode.

### 3.2 TEST MODE

The 104D has a Test Mode which can be entered by simultaneously pressing all 3 front panel keys. The tests are as follows:

*Low Test* By pressing the ACCUM TOTAL key, the low alarm output (if installed) will go low. If a 4-20mA option is installed, the output will go to 4mA.

*High Test* By pressing the RESET key, and depending on the programmed pulse output mode, the high alarm output (if installed):

- will go low if CALO = 0 (high alarm output).
- will output 100ms pulses every 0.5 sec if CALO = 1 (scaled pulse output).
- will output 1ms pulses every 0.5 sec if CALO = 2 (unscaled pulse output).

If a 4-20mA option is installed, the output will go to 20mA.

*Display Test* By pressing the PROGRAM key, all segments of the display will flash.

To exit Test Mode, all three front panel keys are pressed simultaneously.

## 6 Operation

### 3.3 FILTERING

Frequency fluctuations caused by pulsating flow through a flowmeter can interfere with the precision of the rate. For this reason, the Model 104D has a digital filter which will average out these fluctuations and enable accurate readings.

The degree of filtering of the input signal can be adjusted depending on the amount of fluctuation and the particular application. Values from 1 to 99 can be programmed *where 1 corresponds to no filtering and 99 corresponds to heavy filtering*. Such flexibility in filtering means that highly accurate and stable readings can be obtained.

When programming the degree of filtering, it is advisable to start with no filtering (the factor equals 1) and gradually increase until a steady reading is obtained. It is important that the filtering is not too heavy because this will cause an overdamped response.

The following graph shows the time to reach 90% and 99% of a new reading for a step change in input signal.

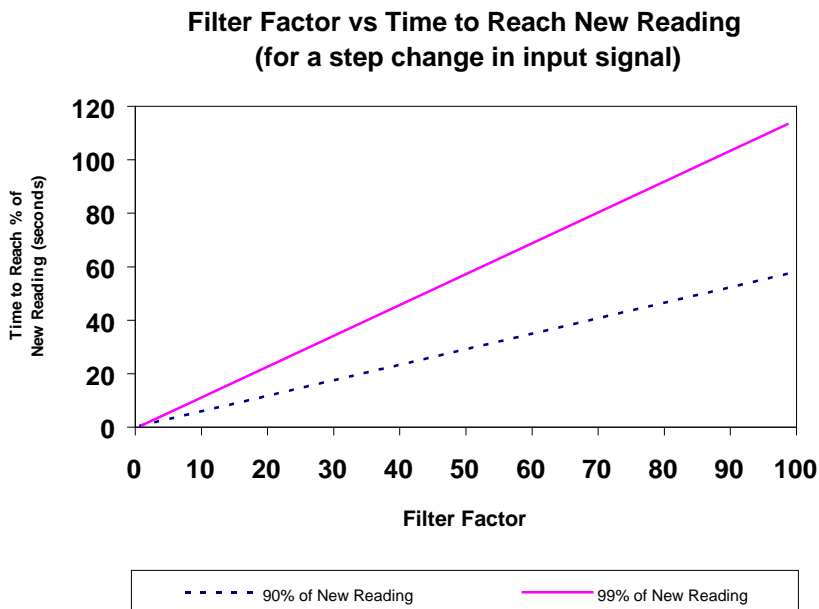

### 3.4 CALCULATION OF RATE AND TOTAL

The flow rate, R, is calculated as follows:

$$R = \frac{f \times H}{S}$$

where  $f$  is the input frequency in Hz (pulses/second).

$H$  is the timebase of rate and is 1 for seconds, 60 for minutes, 3600 for hours and 86,400 for days.

$S$  is the scaling factor (pulses/unit volume).

The scaling factor, S, is equal to the K-factor of the flowmeter expressed in pulses per unit volume. The K-factor is flowmeter dependant and is supplied with the flowmeter. It will be either on a calibration certificate or stamped on the body of the meter.

The user programs the scaling factor and selects the timebase during the programming procedure.

## 8 Operation

### 3.5 TOTAL CONVERSION

The Total Conversion Factor is programmed to enable the **rate** to be displayed in one engineering unit and the **totals** to be displayed in another. For example, the rate can be displayed in gallons/minute and the totals in barrels.

The Total Conversion Factor is a division factor which is used to convert the totals to a different unit. Therefore, it only affects the totals (both resettable and accumulated).

#### Example.

If the Rate is required in gallons/minute:

1. The Scaling Factor would be programmed as pulses per gallon.
2. The Timebase would be programmed as minutes.

If the Totals are required in barrels:

1. The Total Conversion Factor is programmed as 42 because there are 42 gallons in a barrel. All totals will now totalise in barrels.

Below is a table containing common units and their corresponding Total Conversion constants:

<u>Rate/Unit Time</u>	<u>Totals</u>	<u>Total Conversion Factor</u>
Gallons (US)/Unit Time	Barrels (oil)	42.000
Litres/Unit Time	Kilolitres	1000
Litres/Unit Time	m <sup>3</sup>	1000
ml/Unit Time	Litres	1000
Mgallons/Unit Time	Acre-feet	0.32587

### 3.6 FREQUENCY CUTOFF

A frequency cutoff can be programmed below which flow rate is not registered.

Input frequencies at or below the cutoff are totalised, however, the rate is displayed as zero.

The frequency cutoff has a default value of 0.25Hz. The cutoff should be left as 0.25Hz unless the flowmeter in use has a lower frequency.

Note that a low cutoff frequency will result in a correspondingly low response of flow rate update. For example, if the cutoff is set to 0.01Hz the 104D will continue to display the flow rate for 100 seconds even if the signal stops. This is because a cutoff frequency of 0.01Hz means that the time interval between signals is 100 seconds (period =  $1/\text{frequency}$ ). Therefore, the Model 104D must wait 100 seconds before it can determine that the flow has actually stopped.

## 10 Programming

# 4. PROGRAMMING

The Model 104D is fully programmable with all parameters being stored in non-volatile memory.

The Program Mode can be entered in one of two ways:

1. By removing the lower cover strip (ie. the dark grey strip along the bottom of the enclosure) and replacing it the wrong side up. This brings a small magnet on the inside of the cover strip in contact with a reed switch inside the instrument.
2. By removing the front section of the enclosure which contains the main processor board and batteries.

The PROGRAM switch is used to step through the program (CAL sequences) and the ♦ (ACCUM TOTAL) and < (RESET) keys on the front panel are used to change and increment the flashing digits. *Note that only flashing digits can be changed.*

Up to nineteen CAL steps are accessible depending on which options are installed. The CAL number is displayed on the lower display and the parameter is displayed above it.

Parameters in Program Mode that consist of the two parts, **whole numbers** and **digits after the decimal point**, are restricted to having a maximum of 6 significant digits. Therefore the number of significant digits entered in the *whole numbers* determines the number of digits that are able to be entered in the *digits after the decimal point*.

### For Example

- 000001 in the whole numbers makes 00000 available after the decimal place.
- 000100 in the whole numbers makes 000 available after the decimal place.
- 010000 in the whole numbers makes 0 available after the decimal place.

## 4.1 PROGRAM STEPS

<i>Step</i>	<i>Comment</i>
CAL 0	<p><b>Pulse Output</b></p> <p>0 = No pulse output, low and high alarms.            1 = Scaled pulse output and low alarm.            2 = Unscaled pulse output and low alarm.</p>
CAL 1	<p><b>Scaling Factor - whole numbers.</b></p>
CAL 2	<p><b>Scaling Factor - digits after the decimal point.</b></p> <p>The scaling factor is the pulses per unit of measure (eg. pulses/litre, pulses/gallon, etc). The scaling factor can be programmed in the range of 0.000001 - 999,999.</p> <p>See Section 3.4.</p>
CAL 3	<p><b>Cutoff Frequency.</b></p> <p>This determines the cutoff frequency in the range of 0.01 - 0.99Hz. The default setting is 0.25HZ.  <i>Note that care must be taken when programming this value because a low value may cause a slow update time.</i></p>
CAL 4	<p><b>Decimal Point for Rate Display.</b></p> <p>The flow rate can be displayed with 0, 1, 2 or 3 decimal point places.</p>
CAL 5	<p><b>Timebase for Rate.</b></p> <p>The rate can be displayed in units per second, minute, hour or day.</p> <p>0 = second            1 = minute            2 = hour            3 = day</p>



## 12 Programming

<i>Step</i>	<i>Comment</i>
L 6	<p><b>Filter.</b></p> <p>The filter constant for filtering the input signal.</p> <p>1 No filtering. to 99 Very heavy filtering.</p>
CAL 7	<p><b>Decimal Point for Total Display.</b></p> <p>The totals can be displayed with 0, 1, 2 or 3 decimal points.</p>
CAL 8	<p><b>Total Conversion Factor - whole numbers.</b></p>
CAL 9	<p><b>Total Conversion Factor - digits after the decimal point.</b></p> <p>The total conversion factor enables the rate to be displayed in one engineering unit and the totals to be displayed in another engineering unit. The total conversion factor can be programmed in the range of 0.000001 - 999,999.</p> <p>Set to 1.000 if totals and rate are in the same unit, eg. litres.</p> <p>See Section 3.5.</p>
CAL 10	<p><b>Low Alarm - whole numbers.</b></p>
CAL 11	<p><b>Low Alarm - digits after the decimal point.</b></p> <p><i>CAL 10 to CAL 13 are displayed regardless of whether the high and low alarms are installed. If the high and low alarms are not installed, these parameters can be ignored.</i></p> <p><i>CAL 10 &amp; 11 program the flow rate below which the low alarm relay will close. The value can be programmed in the range 0.000000 to 999,999.</i></p>

<i>Step</i>	<i>Comment</i>
CAL 12	<b>High Alarm or Pulse Output Factor - whole numbers.</b>
CAL 13	<b>High Alarm or Pulse Output Factor - digits after the decimal point.</b>  CAL 12 & 13 program the flow rate above which the high alarm relay will close. The value can be programmed in the range 0.000000 to 999,999.  If the scaled pulse output is selected (see CAL0 = 1), then the value will represent the total per pulse, eg. 5 litres per pulse.
CAL 14	<b>4mA Retransmission - whole numbers.</b>
CAL 15	<b>4mA Retransmission - digits after the decimal point.</b>  CAL 14 to CAL 15 represent the flow rate at which 4mA will be output. If the 4-20mA retransmission is not installed, these parameters can be ignored.
CAL 16	<b>20mA Retransmission - whole numbers.</b>
CAL 17	<b>20mA Retransmission - digits after the decimal point.</b>  CAL 16 & 17 are the flow rates at which the output will reach 20mA.
SOFT	<b>Software Version.</b>

## 14 Example

# 5. EXAMPLE

A flowmeter produces 20.538 pulses per litre and has a maximum output frequency on 200Hz. It is required to display the flow rate in litres/min with 1 decimal point and the total in litres with no decimals. A 4-20mA output is installed and 4mA is to represent 0 litres/m and 20mA is to represent 500 litres/m. The instrument is then programmed as follows:

Calibration mode is entered by removing the lower cover strip (ie. the dark grey strip along the bottom of the enclosure) and replacing it the wrong side up.

The following values are then entered:

<i>Step</i>	<i>Value of Parameter</i>	<i>Description</i>
CAL00	1	Scaled Pulse Output
CAL01	00020	Scaling Factor (whole numbers)
CAL02	5380	Scaling Factor (decimals)
Cal03	0.25	Cutoff Frequency
Cal04	1	Rate decimal position
Cal05	1	Timebase
Cal06	01	Filter disabled
Cal07	0	Total decimal position
Cal08	0001	Total Conversion (set to 1.0000)
Cal09	0000	Total Conversion (decimals)
Cal10	00000	Low Alarm
cal11	0000	Low Alarm
Cal12	00000	High Alarm
Cal13	0000	High Alarm
Cal14	00000	4mA Output (whole numbers)
Cal15	0000	4mA Output (decimals)
Cal16	00500	20mA Output (whole numbers)
Cal17	0000	20mA Output (decimals)
SOFT	X.XX	Software Version

## 6. OUTPUTS

This version combines features of the DC powered with a 4-20mA output.

The 4-20mA output provides a two-wire retransmission of the flow rate. Both the 4mA and 20mA points are fully programmable so that the output can span across the entire operating range or, alternatively, across a small section of the operating range.

The instrument draws its operating power from the 4-20mA loop and uses lithium batteries for backup if the 4-20mA loop is interrupted. The alarm/pulse outputs are not supported if the 4-20mA loop is interrupted.

The two Lithium cells are 3.6V, AA types. e.g. TADIRAN SL360/S, SAFT LS14500EX. Note the battery polarity when replacing.

### Specification

Resolution and Linearity:	0.05% of span.
Accuracy:	0.05% of span at 25°C. 0.1% (typ) of span, full temperature range.
Response (4-20mA):	0.5 second.
Loop Power Supply:	9-28 Volts.

Since the 4-20mA output is designed to provide power to the Model 104D, it is not isolated from the input. Hence, all sensors *must* be self-powering (such as reed switches and coils). If external power is required to power the sensor (eg. Namur switches, Hall effect sensors or opto-sensors), the power supply delivering the external power must be isolated from the 4-20mA loop supply

### Typical Connection

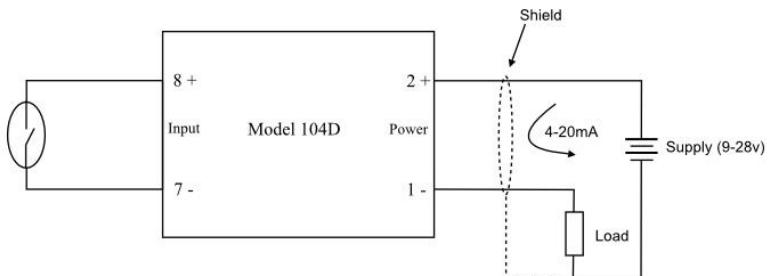

MAN

## 16 Outputs

### *Connection to a Sensor requiring External Power*

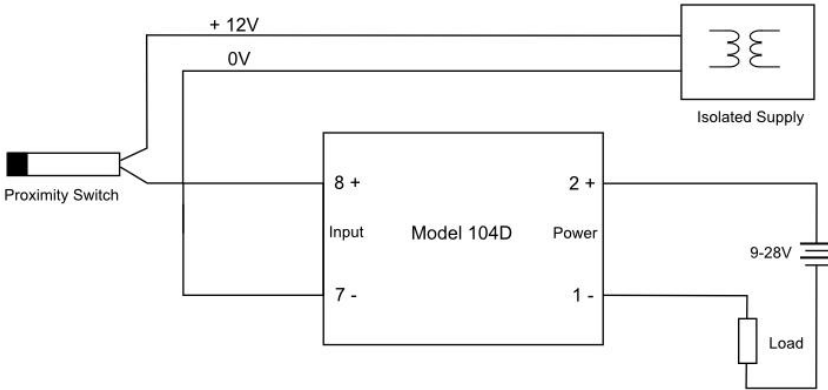

Open collector outputs are also provided for high and low flow rate alarms. If a pulse output is programmed, terminals 6 and 5 will act as a pulse out. The output can sink up to 750mA and can be used to power external relays, lights or audible alarms. The outputs are internally protected against voltage spikes caused by relays and coils.

Both outputs are separately isolated via opto-isolators.

The switching points can be programmed during the setup mode and the low flow alarm will switch on whenever the flow rate drops below the programmed flow rate. Similarly, the high alarm switches on whenever the flow exceeds the high setpoint.

If a scaled pulse output is programmed, a pulse will be output every preset value of the total. For example, if the total is in litres, then programming 5 will output one pulse every 5 litres. If an unscaled pulse output is programmed, output pulses will follow input frequency from a flowmeter. Specification for Alarm Outputs

Maximum Current (sink): 750mA.  
Maximum Voltage: 30Vdc.  
Saturation Voltage: 0.8Vdc across outputs when in the "on" state.

Isolation: Both outputs are separately isolated.

Pulse Frequency: 500Hz maximum.

Pulse Duration: 1ms if CALO = 2 (unscaled pulse output).  
 If CALO = 1 (scaled pulse output) the duration of the pulse automatically adjusts to the output frequency:

- 1ms if output > 50Hz.
- 10ms if output = 5...50Hz.
- 100ms if output < 5Hz.

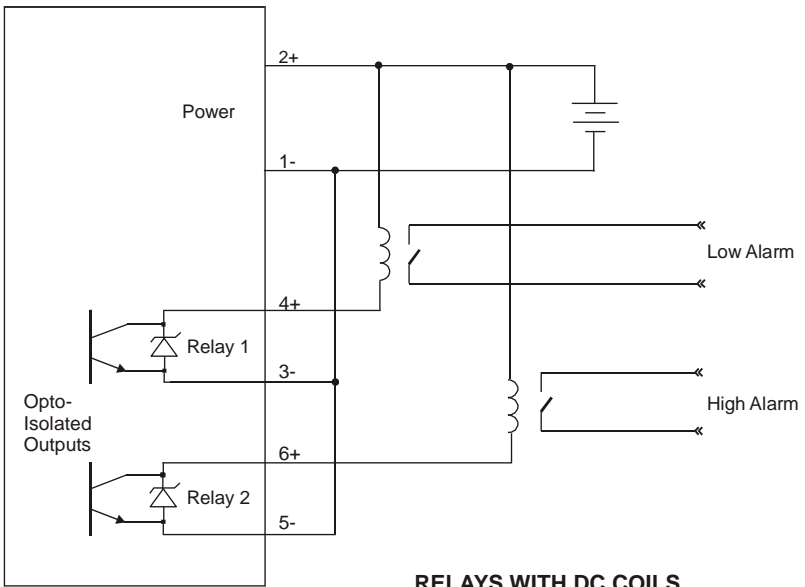

# 7. FLOWMETER INPUT

The Model 104D has an input conditioning circuit which will accept signals from most **pulse** or **frequency** producing flowmeters. Links on the LCD panel enable the input circuit to be configured for different signal types.

The input will interface directly to:

- ◆ Turbine flowmeters.
- ◆ Open collector outputs.
- ◆ Reed switches.
- ◆ Logic signals.
- ◆ Two-wire proximity switches.

The following pages give examples of interconnection to various signal outputs. A circuit diagram of the input is also provided.

For pulse or logic type signals, the input switching threshold is 1.3 volts. That is, the input signal must have a "low" voltage of less than 1.2 volts and a "high" voltage of greater than 1.4 volts.

For flowmeters with coils, the minimum input voltage is 15mV P-P.

All inputs are protected for over voltage up to 28 volts.

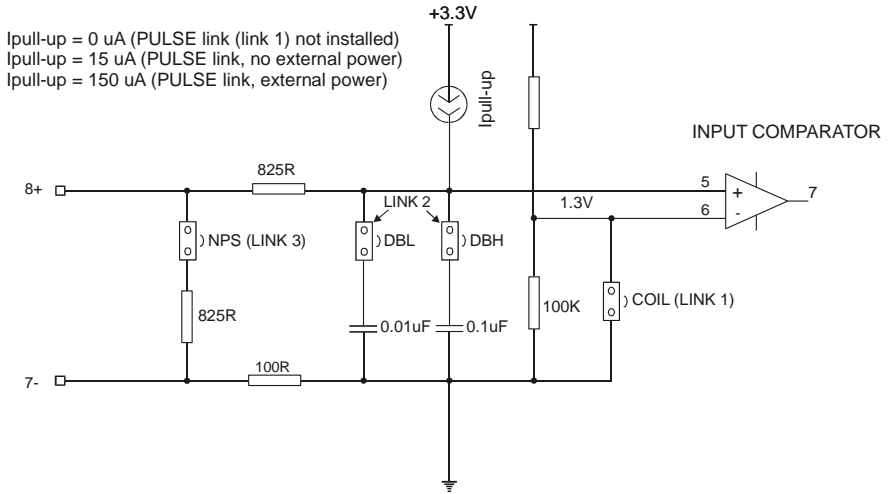

SIMPLIFIED FREQUENCY INPUT CIRCUIT



## 20 Flowmeter Input

### 1. Squarewave, CMOS or Pulse

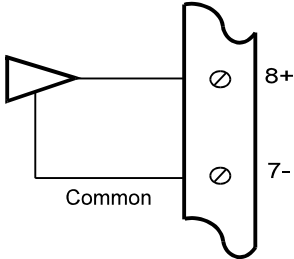

Link Settings

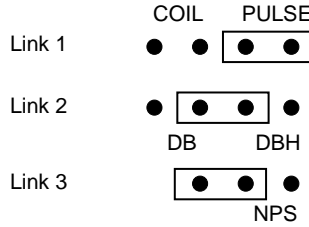

Switching threshold voltage is 1.3 volts.

### 2. Open Collector

With 15 $\mu$ A/150 $\mu$ A internal pull up current

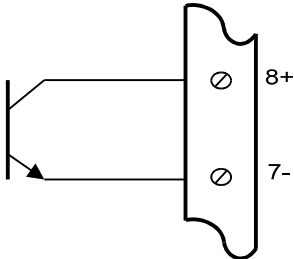

Link Settings

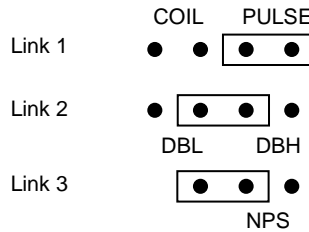

### 3. Reed Switch - Battery Powered

With 15 $\mu$ A internal pull up current

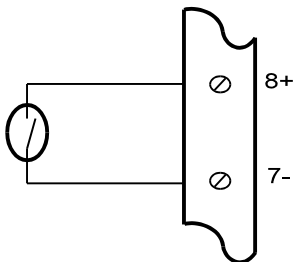

Link Settings

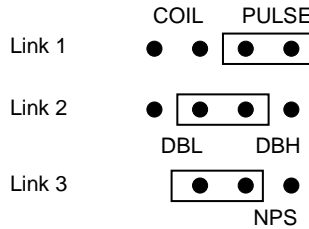

eg. Positive displacement flowmeters with reed switch outputs.

Note: For a switch or reed input with contact bounce link DBL can be switched "on". This will eliminate the effect of switch bounce while limiting the input frequency to 200Hz.

**4. Reed Switch - External DC Power**

With 150µA internal pull up current

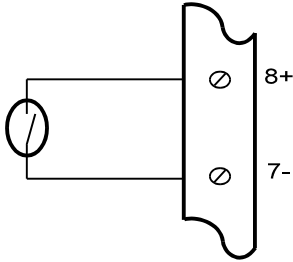

Link Settings

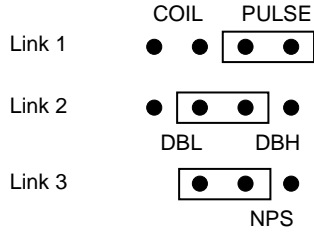

Note: For a switch or reed input with contact bounce link DBH can be switched "on". This will eliminate the effect of switch bounce while limiting the input frequency to 200Hz.

**5. Coils**

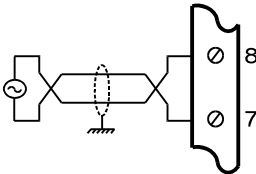

OR

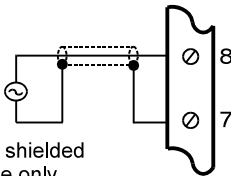

Use shielded cable only

Link Settings

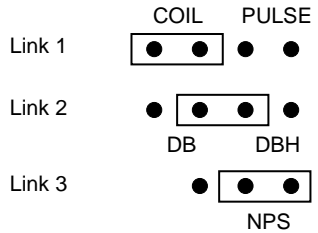

**825R input impedance**

eg. Millivolt signal from paddlewheel or turbine (15mV P-P minimum).

**Note: If the input has a very high impedance, the following link settings should be used:**

Link Settings

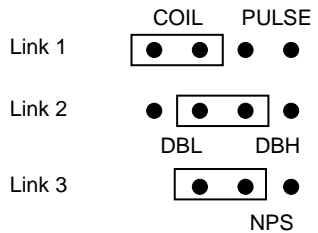

## 22 Flowmeter Input

### 6. Namur Proximity Switch

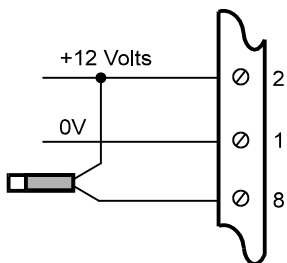

#### Link Settings

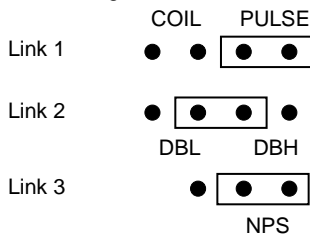

**825R input impedance**

For IS connections of Namur switches see Section 8.

Note: Use this connection for a DC powered version of the Model 104D.

### 7. Namur Proximity Switch - External DC Power

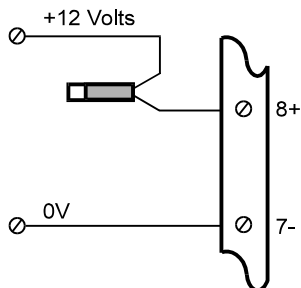

#### Link Settings

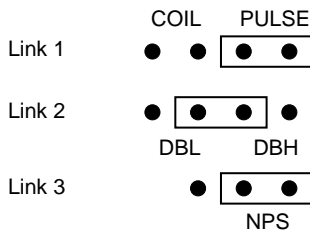

**825R input impedance**

Note: Use this connection for battery or loop powered versions of the Model 104D.

If a 4-20mA output is installed, the supply to the proximity switch must be isolated.

## 8. INSTALLATION

### 8.1 WALL MOUNTING

A wall mounting bracket is supplied with each instrument. Round head screws should be used to attach the bracket to the wall (countersunk screws should not be used). The bracket is mounted first with the tray section at the bottom. The instrument is then mounted on the bracket with two screws as shown below.

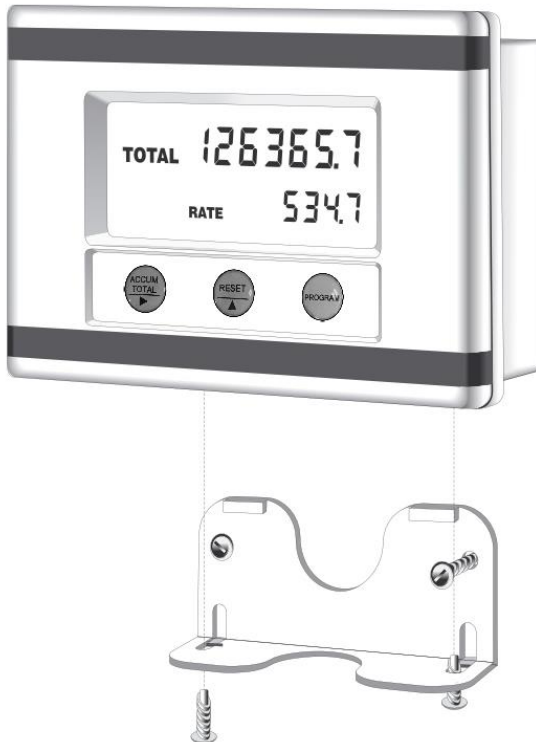

## 24 Installation

### 8.2 REMOVING THE FRONT PANEL

The front panel should be removed as follows:

1. Remove the top and bottom cover strips (ie. the dark plastic strip) by levering a screwdriver under one end.
2. Undo the screws retaining the front. Do not remove the screws, they are retained by O-rings.
3. Remove the front panel from the housing.

To replace the front cover, follow the above procedure in reverse. Ensure that the front panel is aligned at connector points before tightening the screws.

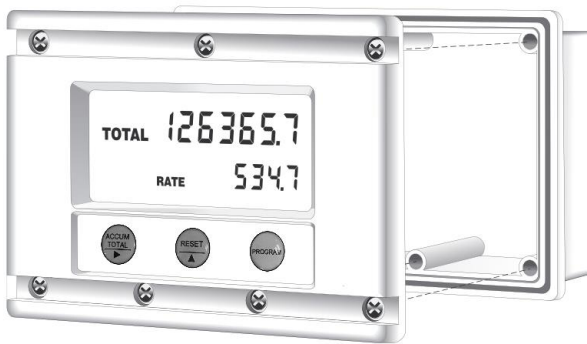
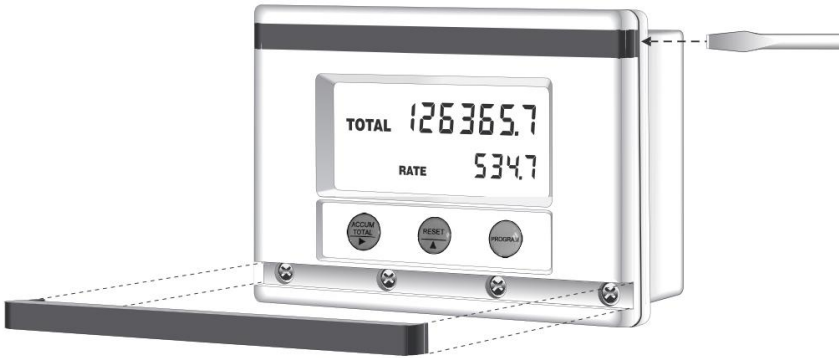

## 26 Installation

### 8.3 THE MAIN ELECTRONICS

The front section of the housing contains the microprocessor and display. It is possible to adjust the display contrast via a small potentiometer on the board. The Display Contrast is shown below and this can be adjusted for optimum contrast.

Adjacent to this control is a RESET switch which can be used to reset the microprocessor. *Note that pressing this button will set all totals to zero.*

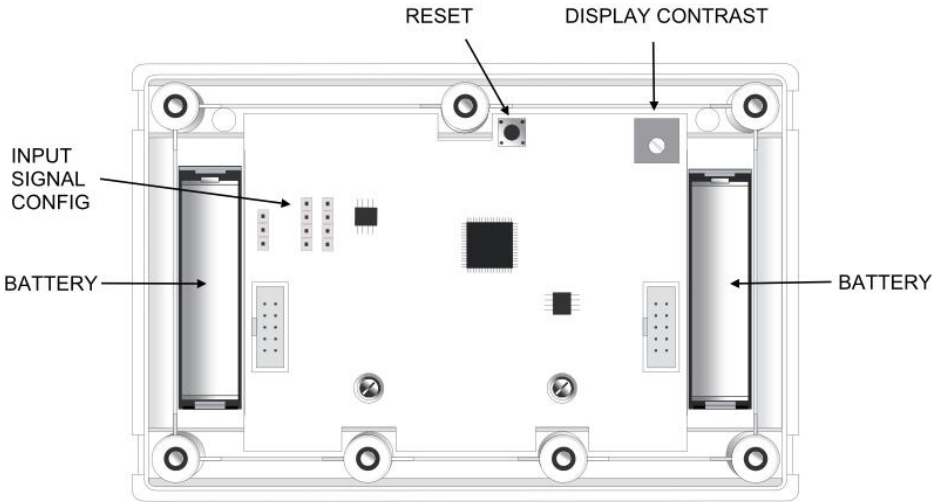

## 8.4 WIRING

When connecting the 104D it is good practice to use shielded cable. The shield should be connected to earth at one end of the cable. The other end of the shield should not be connected.

This wiring practice is mandatory in order to comply with the requirements for Electromagnetic Compatibility as per EMC-Directive 89/336/EEC of the Council of the European Community.

## 8.5 MAINTENANCE

All printed circuit boards must be repaired by Contrec Manufacturing Ltd.

## 8.6 TERMINAL DESIGNATIONS

### S1104D, J2

- |   |   |
|---|---|
| 7 | Pulse (-) / Coil Input                          |
| 8 | Pulse (+) / Coil Input                          |
| 5 | High Alarm (-) or Pulse Output (-) if installed |
| 6 | High Alarm (+) or Pulse Output (+) if installed |
| 3 | Low Alarm (-) if installed                      |
| 4 | Low Alarm (+) if installed                      |
| 2 | 4-20mA (+)                                      |
| 1 | 4-20mA (-)                                      |

### S100C, J5 - Remote Switches.

- |   |                     |
|---|---------------------|
| 1 | Sw1 ( Accum Total ) |
| 2 | Gnd                 |
| 3 | Sw2 ( Reset )       |
| 4 | CAL.                |
| 5 | Gnd                 |
| 6 | Gnd                 |
| 7 | Sw3 ( Program )     |

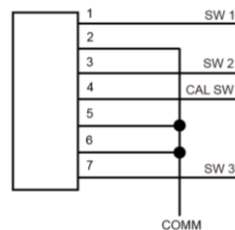



# Index

4-20mA Output, 15

## A

Accumulated Total, 4  
Alarm Outputs, 16

## B

Battery Powered, 15

## C

CAL Sequences, 11  
Cutoff Frequency, 9

## D

DC Power, 15  
Decimal Point, 11, 12  
Display, 4,5  
Display Test, 5

## F

Filtering, 6  
Flow Rate, 7  
Frequency Cutoff, 9

## H

High Alarm, 13  
High Test, 5

## I

Input Signal, 18  
Installation, 23

## L

Link Settings, 20  
Low Alarm, 12  
Low Test, 5

## O

Operating  
  Temperature, 3  
Operation, 4

## P

Programming, 11  
Protection, 3  
Pulse Output, 11

## R

Rate, 7  
Removing the Front  
  Panel, 24  
Remote Switches, 27  
Resettable Total, 4

## S

Scaling Factor, 7, 11  
Specification, 2

## T

Temperature, 3  
Terminal  
  Designations, 26  
Test Mode, 5  
Timebase, 11  
Total Conversion, 8

## W

Wall Mounting, 23