

Installation & Maintenance Instructions

HYBRID DEWPOINT TRANSMITTER



Supplied by

247cable.com

Call us on +44 (0)118 916 9420 | Email info@247able.com

When calling your representative for technical support, please have your serial numbers available. The Sensor and Instrument Serial Numbers are engraved on them.

Sensor Serial No.: _____

Instrument Serial No.: _____

Your Representative is:

Except as may be provided by contract, this document and all specifications and drawings contained are the property of Xentaur Corporation, are issued in strict confidence, and shall not be reproduced or copied or transmitted, in any form or by any means, or used as the basis for the manufacture or sale of apparatus, programs, or services without permission.

Check the Internet for updates; the latest revision of this manual is available in Adobe Acrobat format at:
<http://www.xentaur.com>

Document No.: DPT.00.D.1068 Rev.1 8/11/05

Copyright © 2005 by Xentaur Corporation

Xentaur reserves the right to change or modify the product specification and / or appearance at any time without notice. Therefore, the information in this document is subject to change without notice and does not represent a commitment on the part of Xentaur Corporation.

The customer agrees that in accepting and using this instrument Xentaur Corporation's liability arising from or in any way connected with this instrument shall be limited exclusively to performing a new calibration or replacement or repair of the instrument or sensor, at Xentaur's sole option, as covered by Xentaur's warranty. In no event shall Xentaur be liable for any incidental, consequential or special damages of any kind or nature whatsoever, including but not limited to lost profits arising from or in any way connected with this instrument or items hereunder, whether alleged to arise from breach of contract, express or implied warranty, or in tort, including without limitation, negligence, failure to warn or strict liability.

Swagelok, Cajon are trademarks of SWAGELOK Co.

Acrobat is a trademark of Adobe Systems Incorporated

Microsoft Windows is a registered trademark of Microsoft Corporation

HTF is a trademark of Xentaur Corporation

The Xentaur Logo is a trademark of Xentaur Corporation

Examine the HDT package for damage or mishandling. If any damage is evident notify the carrier and request an inspection.

Unpack the box, it should contain: The HDT with sensor in desiccant container, a mating connector, and this manual.

PLEASE READ THIS MANUAL IN WHOLE, PRIOR TO INSTALLING OR REMOVING THE SENSOR FROM ITS SHIPPING CONTAINER.

This manual is organized in three sections:

Section 1 is an overview of the HDT.

Section 2 describes the sensor and sampling techniques.

Section 3 describes the instrument's electrical, and mechanical interfaces.

This manual is intended for those already familiar with the installation, use and maintenance of analytical or process instrumentation.

Warranty

Xentaur instruments are warranted to be free from defects in workmanship and materials. Liability under this warranty is limited to servicing, calibrating, and replacing any defective parts of the instrument returned to the factory for that purpose. Fuses are specifically excluded from any liability. This warranty is effective from the date of delivery to the original purchaser. The equipment must be determined by Xentaur to have been defective for the warranty to be valid. This warranty applies as follows:

- one year for electronics
- one year for mechanical failures to the sensor
- six months for calibrations

If damage is determined to have been caused by misuse or abnormal conditions of operation, the owner will be notified and repairs will be billed at standard rates after approval.

Maintenance Policy

In cases when equipment fault is suspected, please notify your representative of the problem, be sure to provide them with model and serial numbers. If the problem can not be resolved, then ask for a Return Authorization Number (RAN) and shipping instructions. Issuance of an RAN does not automatically imply that the equipment is covered by our warranty, that will be determined after we receive the equipment. Pack the equipment in a suitable box with sufficient padding, include the RAN number on your paperwork, and send the equipment, prepaid, to the designated address. Xentaur will not accept equipment returned without an RAN, or with reversed shipping or import/export charges. If the warranty has expired, or the damage is due to improper use or exposure of the equipment; then Xentaur will provide an estimate and wait for approval before commencing repairs.

For your convenience a Return Authorization Request Form is provided in appendix J, it must be filled out and sent back to Xentaur in order to obtain a RAN.

HDT User's Manual Table of Contents

1.0 Overview of the HDT	1
2.1 Precautions using the sensor	3
2.2 Sensor Technical Specifications	4
2.3 Sensor Installation & Sampling Techniques	4
2.3.1 In-situ Installation	5
2.3.2 Extractive Installation	6
2.4 Troubleshooting unexpected readings	9
3.1 Precautions using the HDT	13
3.1.1 Electromagnetic Compatibility Considerations	13
3.2 Instrument Technical Specifications	14
3.3 Installation	15
3.3.1 Mechanical Installation	15
3.3.2 Electrical Installation	15
3.4 Operating the Instrument	17
3.4.1 Starting up	17
3.4.2 HART Interface	17
3.5 Troubleshooting the Instrument	17
Appendix A: HDT power-on sequence, timing diagram ..	19
Appendix B:HDT pin 3 timing diagrams	20
Appendix C: HDT Mechanical Drawing	21
Appendix D: HDT Block Diagram & Connections	22
Appendix E: Certifications - Approvals - Conformity	24
Appendix G: Current vs. Dewpoint	28
Appendix H: Uncertainty in LBS & ppmV calculations ..	31
Appendix I: Sensor Response Time	32
Appendix J: Return Authorization Request	33

HDT User's Manual

1.0 Overview of the HDT

The HDT is a microprocessor based 4-20mA loop powered (2 wire) hygrometer, for measuring moisture content in gases or liquids in a wide range from -100°C to +20°C dew-point in gases; and 0 ppmW to 1000 ppmW in liquids. The measurement is transmitted by varying the current drawn (4-20mA) from the power supply. The current varies linearly proportional to the selected measurement units. In addition a digital output modulates/demodulates the 4-20mA loop line without interfering with its operation, and adheres to the HART protocol. Thus the HDT is capable of communicating with properly equipped Personal Computers or other RS-232 or HART capable controllers. The HDT's advanced design allows it to be housed in a small stainless steel enclosure behind the sensor probe, thus the instrument and sensor are a single integrated unit.

The HDT uses the Xentaur HTF™ sensor which is encapsulated in sintered stainless steel, thus it is capable of coming into contact with a wide variety of environments. However one should keep in mind that the sensor is a sensitive device and it should be handled accordingly.

2.1 Precautions using the sensor

The Xentaur HTF™ Al₂O₃ sensor is designed and field proven to be highly reliable, rugged and maintenance free. However the user should consider the following precautions:

- *To avoid the need for prolonged dry-down (when expecting to measure dewpoints dryer than -65°C), do not expose the sensor to room air longer than necessary (1 - 2 minutes). Thus, do not open the sensor container before you are ready to install the sensor.*
- *The sensor container has desiccant to keep the sensor dry during shipping and to avoid damage due to condensation. Close the container immediately after removing the sensor to avoid degradation of the desiccant.*
- *Do not throw away the sensor container, you may use it again to transport the sensor between locations, to store it between uses or to ship it back to the factory for certification. The container can be attached to the loop cable, by trapping the cable with the lid strap.*
- *Do not expose the sensor to corrosive gases or liquids such as ones containing Chlorine, Ammonia or HCl. (SO₂ can be monitored when the moisture content is low). Cyanide, Br₂, I₂, and HNO₃ may harm the gold layer of the sensor, thus limiting sensor life.*
- *Except for the XTR-60 and XTR-LQ sensors:*
 1. *Do not expose the sensor to liquid water, as it may get damaged.*
 2. *Do not breathe directly onto the sensor, as condensation may form which could damage the sensor element.*
- *Do not install the sensor near heat sources such as radiators or air ducts.*
- *Do not install the sensor in places subject to extreme mechanical vibration or shock. If this is not avoidable, use resilient mounting. If in doubt, call your representative.*
- *Do not disassemble the porous metal filter encapsulation, as this will damage the sensor and void your factory warranty.*
- *Prior to installation of the probe, ensure that no contaminants are present in the system (e.g. oil, liquid water).*

2.2 Sensor Technical Specifications

Type:Hyper Thin Film high capacitance Al₂O₃.
Dewpoint range:
XTR-100-148°F to +68°F (-100°C to +20°C)
XTR-65-85°F to +68°F (-65°C to +20°C).
XTR-60-76°F to +68°F (-60°C to +20°C).
XTR-LQ.....for use in liquids.
Capacitance:..... 15nF to 200nF.
Accuracy:±5.5°F (±3°C).
Repeatability:±0.9°F (±0.5°C).
Response time:see graph in Appendix I.
Temperature range:-10°C to +70°C.
Sample Flow range:(linear velocity @ 1ATM):Static to 100m/s.
Storage temperature:-40°F to+176°F (-40°C to +80°C).
Mechanical:encapsulated in 100μ sintered stainless steel.
Calibration method:NIST/NPL traceable multi-point factory calibration.

2.3 Sensor Installation & Sampling Techniques

Keep in mind that the moisture content at the sensor is not only due to the moisture of the gas being measured, but also due to desorption of water from tubing, trapped moisture (at the interconnection points, valves, filters and other hygroscopic materials in the system), leaks in the system, and others. Thus the measurement may vary from the expectation, and therefore care should be taken in choosing the sampling technique utilized in the measurement. Factors such as gas pressure, flow rate, materials of construction, length and diameter of tubing, number of interconnecting fittings, dead space in tubing and manifolds; will influence the measurement value and response time.

The high capacitance HTF™ sensors can be installed either directly in the line to be sampled (in-situ), or in a slip stream of a sample system (extractive).

To assure a long and accurate performance of the sensor, it should be protected from contaminants such as liquids

(water, oil etc.), and particulates. The sintered stainless steel sensor encapsulation protects from particulates larger than 100 microns, finer particulates (e.g. from degraded desiccant or rust) should be filtered with a particulate filter with suitable capability, do not use hygroscopic filter materials.

2.3.1 In-situ Installation

In-situ installation is recommended only for measurements where the gas pressure is expected to vary little, the gas is expected to be free of contaminants, the gas temperature is within the operating specifications of the sensor, and there is no chance of liquids coalescing. Examples of applications suited for in-situ installations are: pure gases, output of desiccant dryers (for instrument air), glove boxes, etc. For most other applications in-situ installation should be avoided for the following reasons:

- Sample conditioning is almost always necessary to avoid exposure of the sensor to liquid water and other contaminants, such as hydrocarbons, which may damage the sensor or affect accuracy over time.
- Variations in line pressure affect the reading of the sensor because dewpoint varies with pressure.
- If the gas line is under pressure, it is more likely that water condensation occurs which may damage the sensor.
- Under a pressurized system removal of the sensor without the installation of isolation valves can be dangerous.

If in-situ installation is required, bypass mounting is preferable. If in-line installation is required, make sure to install the sensor at the upper surface of the gas line to minimize its exposure to liquid water should condensation occur; the XTR-60 sensor is best suited for these applications. Also consider the need to isolate (depressurize) before installing

or removing the sensor.

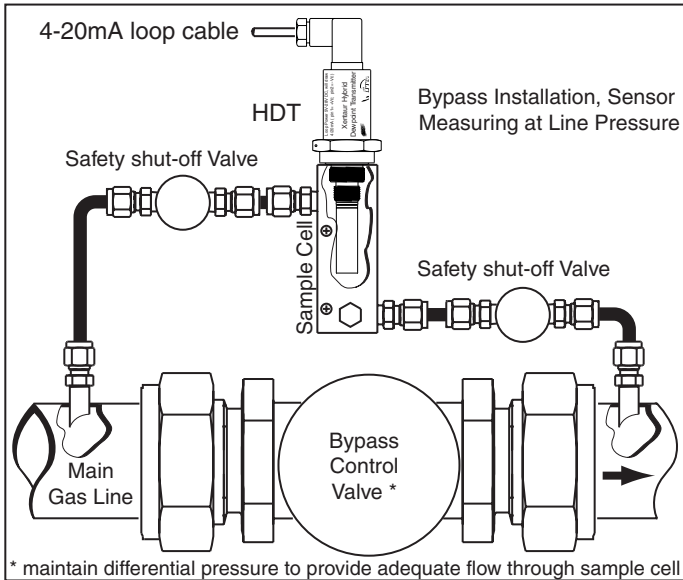
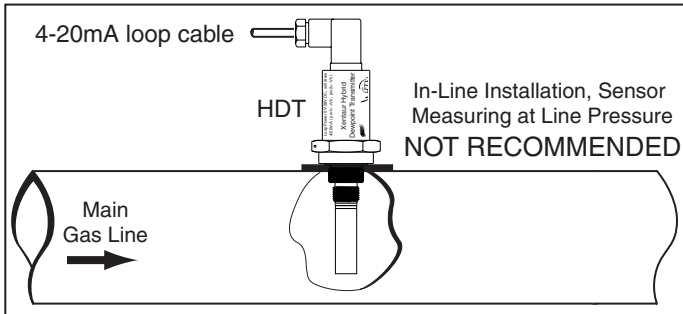

2.3.2 Extractive Installation

For extractive installations we recommend our sample system ESS, which may be equipped with a variety of features, such as: isolation valve, coalescing or particulate filter, pressure regulator, calibration sample injection or extraction port, pressure gauge, flow meter, weatherproof enclosure.

Refer to the ESS literature for more information.

If the resources to make your own sample system are available, the following two diagrams may be used as a guideline to configure a simple system.

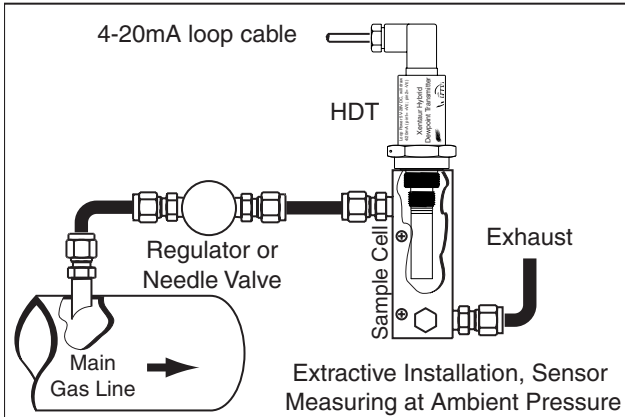
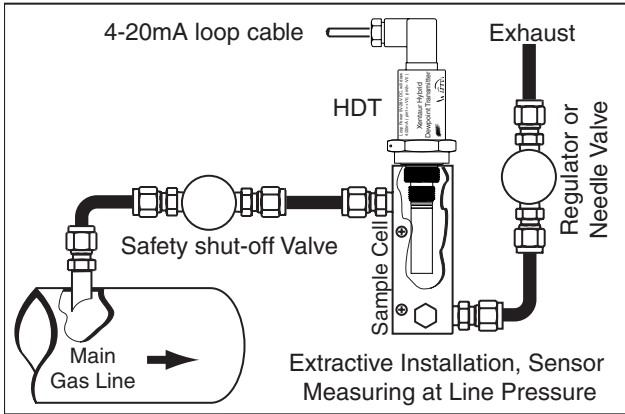

It is generally recommended to measure at ambient pressure for the following reasons:

- The readings will not be affected by variations in line pressure.
- The risk of exposing the sensor to liquid water is significantly reduced.

- ppm readings are computed for a pressure of one atmosphere (1 bar); and have to be corrected using a pressure nomograph, or calculator if the sensor is measuring at different pressures.

If readings at line pressure are necessary, it is recommended to measure at ambient pressure and to use our dewpoint calculator to obtain the dewpoint at line pressure.

Please make sure that:

- The sample is taken from the upper surface of the main gas line. This avoids problems with contamination. The sample should be taken away from pipe line walls where flow rates may be low, and dewpoint changes may lag.
- For dewpoints dryer than -40°F , use stainless steel tubing only. Copper tubing is acceptable for dewpoints wetter than -40°F . Do not use plastic, rubber or tygon tubing under any circumstances, as measurements would be incorrect and/or response time slow due to water retention inside these materials.
- Try to run pipes to the sensor upwards, so that contaminants tend to fall back into the main line.
- Keep the length of the sample line to the sensor as short as possible.
- Use small diameter pipes (1/4" or 1/8" OD).
- Use sufficient flow rates (e.g. 1 l/min with 6 feet of 1/8" piping is adequate). The flow rate will influence the systems' response time.
- Do not install any devices upstream of the sensor, such as other measuring systems, flow meters etc., which are not absolutely necessary as these are potential leak sources.
- Installation of a coalescing and / or particulate filter ahead of the sensor is desirable to prevent any liquid or particulate contamination of the sensor.

- If filters are used upstream of the sensor, make sure these contain non-hygroscopic filter materials only.
- If pressure regulators, shut off valves etc. are used upstream of the sensor, make sure these do not contain rubber or other hygroscopic materials.

2.4 Troubleshooting unexpected readings

If erroneous readings are suspected on a newly acquired instrument, compare the serial number engraved on the sensor sintered filter, to the one stored in the instrument memory. This comparison can be performed utilizing a HART communicator. The two should be the same; if they are not, the instrument may not be calibrated with the installed sensor. To troubleshoot other problems, identify the unexpected reading category in the following table, and consider the possible causes and appropriate diagnostic action and remedy.

Troubleshooting unexpected readings (table spans 2 pages)

Symptom	Possible Cause
Reading is not changing	Condensation in sample system.
Slow Response	<ol style="list-style-type: none"> 1. Water vapor in the system. 2. Flow rate too low. 3. Sample pipe too large and/or too long. 4. Unsuitable sample pipe material. 5. Leaks 6. Hygroscopic materials in sample system
Dry Reading	faulty sensor.
Wet Reading	Leak in system or use of unsuitable pipe.
	Comparison of readings with manual cooled-mirror instrument.
current loop outside of 4/20mA range	1. Prolonged exposure to wet gas.
	2. Instrument Failure.
	3. Short circuited sensor.
	4. Open circuit on sensor.
	5. Instrument failure.

For non-sensor related problems (e.g. no reading on instrument) refer to section 3.5

Section 2: Sensor and Sampling Techniques

Troubleshooting unexpected readings (continued from previous page)

Symptom	Diagnostic/Remedy
Reading is not changing	Condensation will occur if the temperature of the sample system, at any point is below (colder) the dewpoint temperature of the sample gas. Once having formed, the sample reaching the sensor will have a dewpoint equal to the temperature of the condensation, regardless of the dewpoint of the sample at the sample point.
Slow Response	It is usually more satisfactory to bleed a sample gas at atmospheric pressure through the sensor sampling chamber, and to use 1/8" (3mm) o.d. sample pipe. See below re: sample pipe material, also see section 2.3
Dry Reading	return sensor for full calibration to your representative.
Wet Reading	Cure the leak, or replace unsuitable pipe with copper or stainless steel. Flexible connections should be made with PTFE pipe. NEVER use rubber or plastic pipe.
	This type of indicator reads about 10°C dry at about -50°C dewpoint due to temperature gradients within the device. The error increases at drier levels.
	Dry the sensor, install sensor in either a known dry gas stream i.e. instrument quality air or dry nitrogen, or place sensor in a dry can or bottle of desiccant and seal the container from outside air (the shipping container is designed for this purpose)
	Remove (unscrew) sensor, if the current does not change even momentarily, then the problem is with the instrument, otherwise the problem may be with the sensor.
	Check sensor connection or replace sensor.

3.1 Precautions using the HDT

The HDT uses state-of-the-art microelectronics to provide a miniature full functioning transmitter. The user should consider the following precautions when using any sensitive electronic device.

- Do not install the unit near heat sources such as radiators or air ducts.
- Do not install the unit in places subject to extreme mechanical vibration or shock. If this is not avoidable, use resilient mounting. If in doubt, call your representative.
- Observe the appropriate electrical safety codes and regulations.

3.1.1 Electromagnetic Compatibility Considerations

The HDT has been designed and verified by testing to meet the requirements of the EC Council EMC Directive 89/336/EEC, for Industrial, Scientific & Medical equipment. The sensor and the 4-20mA loop are electrically connected, however they are isolated from the HDT housing and sample cell fitting threads, refer to Appendix D. Please consider the following electromagnetic interference issues during installation:

- In order to provide an acceptable noise environment for the HDT or any other digital equipment in the proximity of switching inductive loads, it is recommended that there be varistors placed across the inductors to keep down the high voltage spikes during transitions.
- Circuitry activated by relay contacts should account for the contact bounce, one simple debouncing method is placing a capacitor across the relay contacts.
- AC power wiring should be routed as far away from the

HDT and its wiring as practical.

3.2 Instrument Technical Specifications

- Enclosure:Stainless Steel.
- Dimensions & Weight:~1.25" Dia. x ~5.68" long including sensor & connector (see appendix C) 0.5lbs.
- Pressure operating range:Standard:500 PSI (34 bar).
Optional:5,000 PSI (340 bar).
- Operating Temperature:-22°F to 185°F (-30°C to +85°C).
- Mechanical connections:.....14mm x 1.25mm threads, and 3/4"-16 threads, may be outfitted with other threads upon request.
- Electrical connections:Industrial Standard 9.4mm 4pin connector IP65.
- Cable:Two conductor min #24AWG;
for total cable length >5000ft. min #20AWG
cable must be shielded to meet CE requirements;
for ambient temperatures above 60°C assure that wiring temperature rating exceeds the maximum expected ambient temperature.
- Power Requirements:5 VDC (min) to 28 VDC (max), the instrument draws 4-20mA depending on measured dewpoint.
- Input resolution:0.1°C dewpoint.
- Indicators:none.
- Engineering units:factory programmed: °C, °F, ppmV, LBS H₂O/mm scf, gm H₂O/m³, ppmW, water vapor pressure.
- Controls:.....HART interface, user's selections are stored in EEPROM.
- Outputs:.....Analog and digital outputs are available:
A. 4-20mA drawn by the instrument from the power supply.
The 4-20mA is linear to the engineering units, the range is programmable. Output resolution is 0.1°C dewpoint or ~0.25µA whichever is greater.
B. The instrument can supply digital output by modulating the 4-20mA loop line. The interface is defined by HART. In the digital mode the HDT can be remotely operated, the dewpoint & temperature can be read. Multiple units can operate on the same loop cable as a multi-channel instrument.
- Alarms:.....The 4-20mA signal or the digital output may be used by an external device to operate relays. In addition a digital output pin is provided which can be factory programmed to provide dewpoint alarm indications.
- Isolation:Sensor is connected to the current loop but, isolated from the HDT housing and installation threads.
- Approvals/Classifications: ..CE for electromagnetic compatibility, accredited laboratory tested and certified. FM approved for use in Hazardous locations and NEMKO ATEX approved when installed per draw-

ing DPT.00.D.7042. refer to appendix E

3.3 Installation

3.3.1 Mechanical Installation

The HDT has two thread sizes (refer to Appendix C) for mounting to the sample cavity (consult the sensor installation section) where the dewpoint will be measured. Various adapters are available for direct connection into existing system openings. Ask your representative for a Sample Cell, if you do not have the ability to provide an appropriate sample cavity mounting. If the $\frac{3}{4}$ "x16 thread is used then the HDT will seal against the wall of the sample cell with the provided Viton A O-ring. If the 14mm x 1.25 spark plug thread is used then an additional Viton gasket must be installed to provide the proper seal. Ask your representative for this gasket, it is available free of charge. The HDT is light enough such that either thread will mechanically support the whole instrument. To prevent any leaks, tighten the HDT into the sample cavity, with a $1\frac{1}{4}$ " wrench, $\frac{1}{8}$ turn past finger-tight to assure metal-to-metal contact, do not exceed 15 foot-pounds.

The sensor can be removed from the HDT by unscrewing it. Make sure that the sensor is securely fastened to the HDT (the tension washer should be compressed), so that it does not come loose during use, do not overtighten because the sintered material will break.

3.3.2 Electrical Installation

The HDT will operate properly with 5VDC minimum to 28VDC maximum at its input, if this voltage is exceeded the internal fuse may open, this fuse will self reset after a

cooldown time. When selecting the power supply voltage do not neglect the voltage drop across any current measurement resistor and wiring in the loop. The connector is an Industrial Standard 9.4 mm, 4 pin connector. IP65 NEMA 4X. Please observe connector polarity when plugging in the HDT cable. Please align the wider earth ground pin (marked \oplus) to the wider slot on the connector (marked \ominus). Note that the wider slot is on the same side of the connector as the cable grip stem. Make sure that the weatherproofing gasket is seated flat against mating surfaces. Do not force the connector. When the connector engages, secure it with the retention screw.

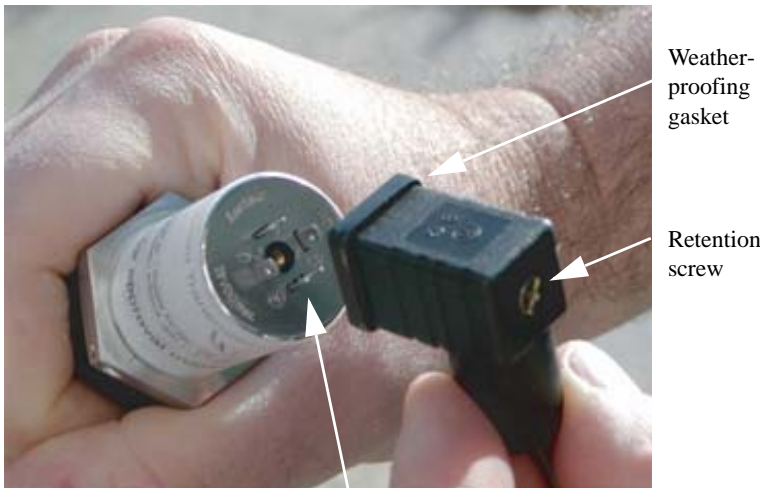

The connector is keyed with a wider earth ground pin.

The HDT will draw 4mA to 20mA from the power supply depending on the dewpoint being measured. The dewpoints corresponding to 4mA and to 20mA are user selectable via the HART interface, in between the current will vary linearly to the programmed engineering units, see appendix G.

Various strategies for interfacing with the HDT are shown in Appendix D.

Please observe good electrical safety and grounding practices when connecting any electrical equipment; connecting one end (e.g. negative) of the power supply to earth ground is advisable.

After the installation is complete, proper detection by the user's equipment of the 4-20mA output, may be verified by confirming the measurements in the first few seconds after power up refer to Appendix A.

3.4 Operating the Instrument

3.4.1 Starting up

The instrument is ready for use as soon as the power cable is installed. When power is applied the instrument will initialize its program refer to timing diagrams in Appendices A & B, then it will enter the Operating State.

3.4.2 HART Interface

The HDT is HART compliant. The *Serial Num* on the HDT body is its HART address. The HDT implements the full Common Command Set in addition to commands xxxx. The full HART specification is available from the HART Communication Foundation at <http://www.hartcomm.org/>.

3.5 Troubleshooting the Instrument

This instrument performs diagnostic tests on power up as well as once every three seconds. The table that follows, depicts possible error/unexpected indications that may occur. For each indication the table has explanations for the reason, and if necessary a suggested action to remedy it.

Symptom (more than 25 sec after powerup)		Possible cause	Remedy
Current Loop	Pin 3		
Fixed at ~3.8mA	High impedance	Instrument failure	Cycle power, if problem persists return instrument
		EEPROM checksum failure	
Fixed at 21mA ‡	Intermittent (0V-3V)	Loop voltage insufficient	Check power supply's capability to maintain at least 5V at 20 mA. see appendix A
		1. open sensor 2. shorted sensor	
4 to 20 mA	1200 baud RS-232 data	<i>Normal Operation</i>	
Fixed at 4mA	RS-232 data	Measurement below HART Command 15 Primary Variable Analog Output Lower Range	Refer to sensor section XXX
Fixed at 20mA		Measurement above HART Command 15 Primary Variable Analog Output Upper Range	
0 mA	High impedance	1. Cable open 2. Fuse open due to excessive voltage	1. Check cables 2. Wait for self resetting fuse cooldown.

Note: ‡ in the factory default mode the HDT is setup using HART Alarm Selection Code (ref Universal command 15) such that when there are errors the current loop draws 21mA. However it is also possible to configure it to 4mA, or 20mA, or 3.8mA, or to hold last output

Appendix A: HDT power-on sequence, timing diagram

Decision tree and Timing diagram of HDT current loop during power on startup

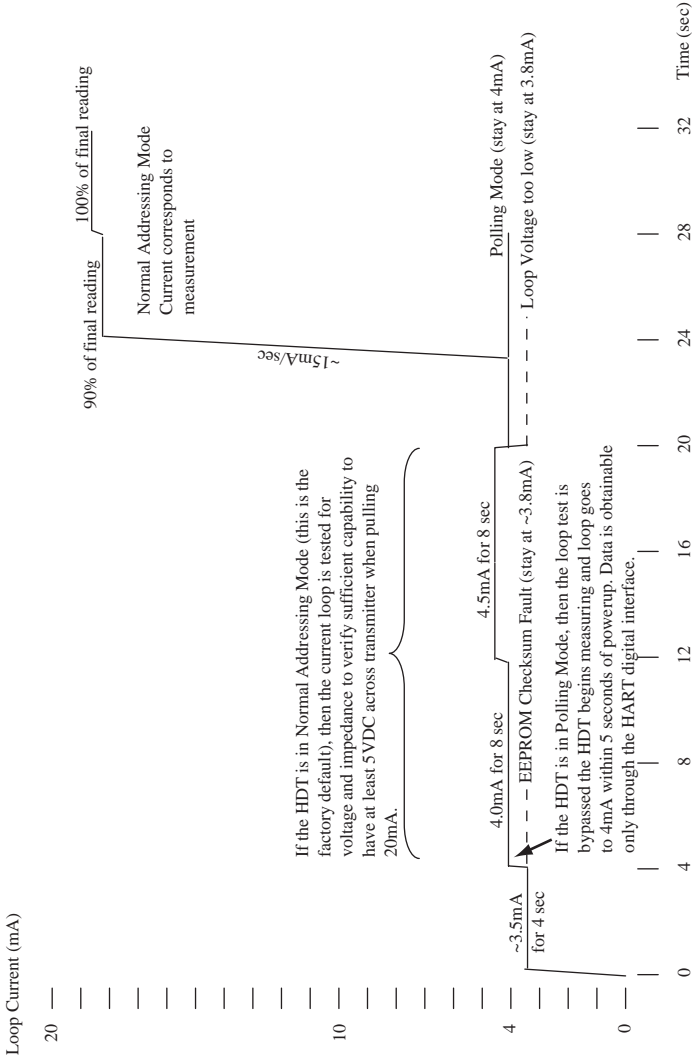

Appendix B:HDT pin 3 timing diagrams

Pin 3 timing diagrams for the 4 possible modes

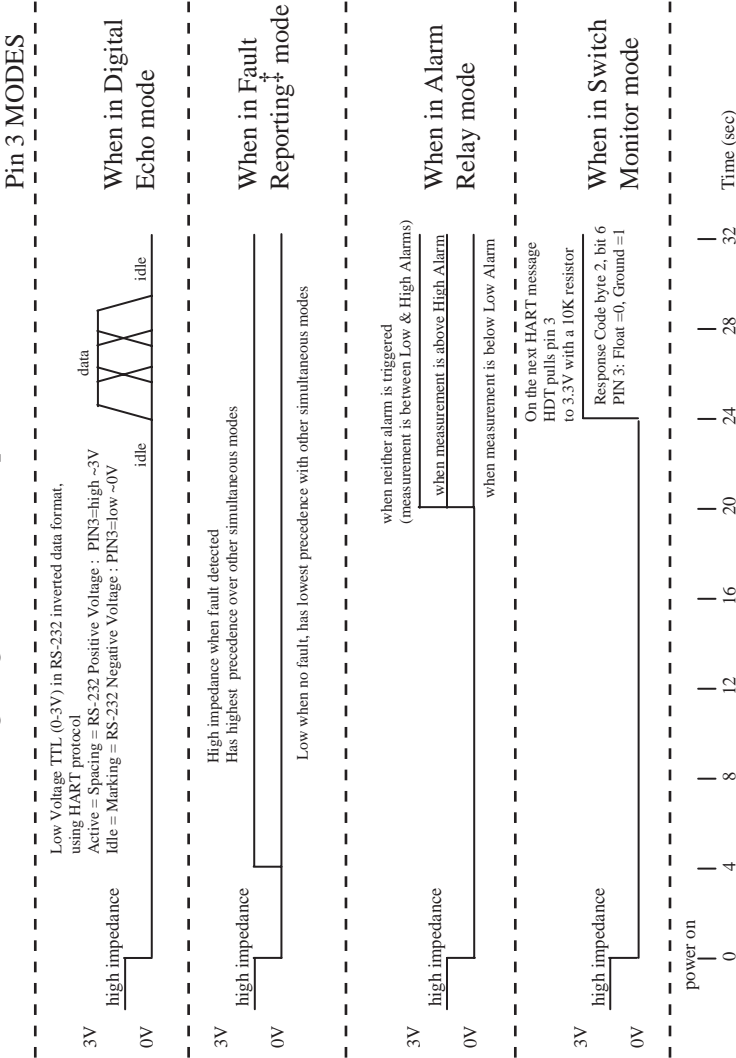

Appendix C: HDT Mechanical Drawing

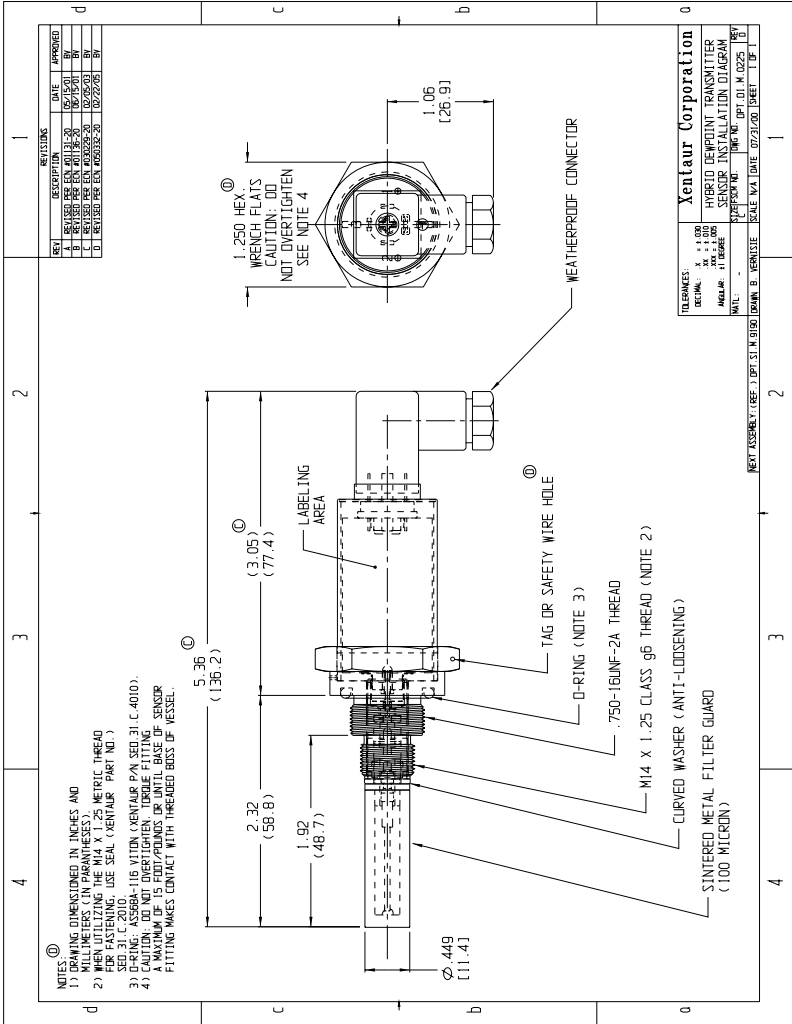

Appendix D: HDT Block Diagram & Connections

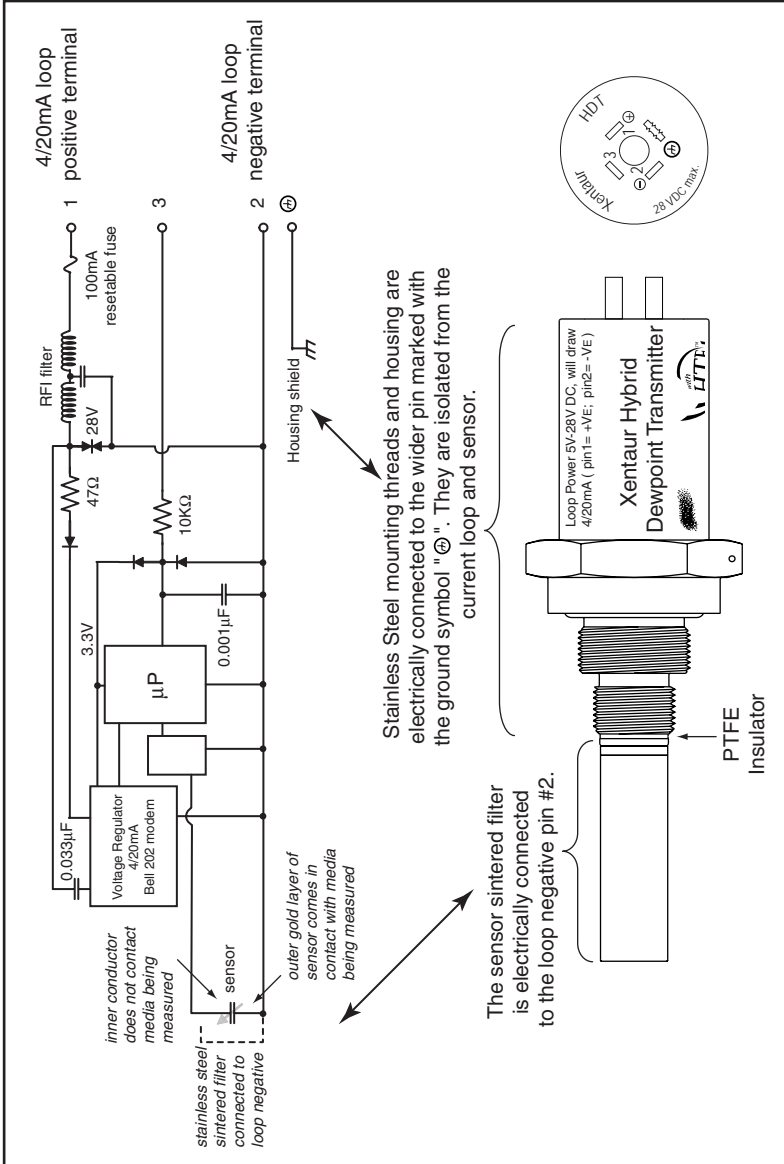

Appendix D: HDT Block Diagram & Connections (cont)

Hookup strategies from preliminary manual

Suggested relay hookup

Appendix E: Certifications - Approvals - Conformity

Revisions			
Rev	Description	Date	Approved
1	I _{max} & C ₁ updated per graph B3 and new capacitor C19	3/7/05	BB
2	P _{max} , V _{max}	6/8/05	BB

HAZARDOUS AREA
IS Class I, II, III Division 1, Group A, B, C, D, E, F, G
T6 at 40 °C ambient & T4 at 85 °C ambient
Class I, Zone 0, AEx ia IIC
and
II 1 GD ATEX EEx ia IIC T6 at 40 °C & T4 at 85 °C

Intrinsically Safe Apparatus

UNCLASSIFIED AREA

Associated Apparatus

Safety Barrier
See Note B

Customer or vendor provided equipment
E.g. Xenataur XDT, Panel Meter, DCS, etc.

The Associated Apparatus must be a linear output device. Control equipment connected to Associated Apparatus must not use or generate more than 250V RMS. Associated apparatus manufacturer's installation drawing must be followed when installing this equipment.

Control Equipment

Notes for installation in North America:

- A. Intrinsically Safe Entity Parameters: $7.4Vdc \leq V_{max} \leq 14.4Vdc$, $I_{max} = 160mAcd$, $P_{max} = 576mW$, $C_1 = 0.656\mu F$, $L_1 = 0mH$.
- B. Intrinsic Safety Barriers must be galvanically isolated or shunt zener diode barriers with linear outputs used channel to channel and having entity parameters such that $7.4Vdc \leq V_{max} \leq 14.4Vdc$, $I_{max} \leq 160mAcd$, $P_{max} \leq 576mW$, $C_1 \geq C_1 + C_2$ and $L_1 \leq L_1 + L_2$.
- C. For Cable and Lcable, if the capacitance per foot or the inductance per foot is not known, then the following values shall be used: Cable = 60pF/foot and Lcable = 0.2uH/foot.
- D. Selected Barriers must be installed in accordance with the barrier manufacturer's control drawing and Article 504 of the National Electrical Code ANSI/NFPA 70.
- E. Installation should be in accordance with ANSI/ISA-81.01-01 "Installation of Intrinsically Safe Systems for Hazardous (Classified) Locations" and the National Electrical Code (ANSI/NFPA 70).

Notes for installation in European Community:

EEX ia IIC T6 ATEX Certificate No. XXXXX

- A. Intrinsically safe circuit parameters: U₁: 14.4Vdc, I₁: 160mAcd, P₁: 576mW, C₁: 0.656uF, L₁: 0mH.
- B. Selected Barriers must be galvanically isolated or shunt zener diode barriers with linear outputs used channel to channel and having entity parameters such that U₁ ≤ 14.4Vdc, I₁ ≤ 160mAcd, P₁ ≤ 576mW, C₁ ≥ 0.656uF and L₁ ≤ 0mH.
- C. For Cable and Lcable, if the capacitance per foot or the inductance per foot is not known, then the following values shall be used: Cable = 20pF/foot and Lcable = 0.66uH/foot.
- D. The wiring of the intrinsically safe circuit may be installed in accordance with EN60079-14 or according to national installation requirements.

General Notes:

- D. Resistance between Intrinsically Safe Ground and earth ground must be less than 1.0 Ohm.
- D. All components must be installed in Class I or Class II environments.
- WARNING** - Substitution of components may impair intrinsic safety.
- WARNING** - To prevent ignition of flammable or combustible atmospheres, disconnect power before servicing.

No revision to drawing without prior FM and NEMKO approval.

<p>XENATAUR Corporation 84F HORSEBLOCK RD. YAPHANK, NY 11980</p>	<p>Control Drawing for Entity Concept Approved Installation of Xenataur HDT-series Downport Transmitter connected to Associated Apparatus, in Hazardous (Classified) Locations</p>	
	<p>Do Not Scale Drawing.</p>	<p>Dwg. No. DPT.00.D.7042</p>
<p>TOLERANCES: (unless otherwise stated) Decimal - 0.010 XXX - 0.005 Angular - 1 deg.</p>	<p>Scale: N/A</p>	<p>Rev 2</p>
<p>Material & Finish: (see Notes)</p>	<p>SIZE A</p>	<p>Date: 11/23/03</p>
<p>Drawn: B.B.</p>	<p>Sheet 1 of 3</p>	

Appendix E: Certifications - Approvals - Conformity (cont)

Revisions		Date	Approved
Rev	Description	Date	Approved
1	I _{max} & C _i updated per graph B3 and new capacitor C19	3/7/05	BB
2	P _{max} I _{max}	6/8/05	BB

HAZARDOUS AREA

IS Class I, II, III Division 1, Group C, D, E, F, G
T6 at 40 C ambient & T4 at 85 C ambient
Class I, Zone 0, AEx ia IIB
and
Class I, Zone 0, AEx ia IIB
C and T4 at 85 C

Intrinsically Safe Apparatus

Connectivity Pairs to Transmitter must be observed.

Xentaur XTR-series Di-wound Sensor Element

UNCLASSIFIED AREA

Associated Apparatus

Customer or vendor provided equipment
E.g. Xentaur XDT, Panel Meter, DCS, etc.

Notes for installation in North America:

- Intrinsically Safe Entity Parameters: $6.7Vdc \leq V_{max} \leq 27.8Vdc$; $P_{max} = 695mW$; $C_i = 0.656\mu F$; $L_i = 0mH$.
- Selected Barriers must be FM approved galvanically isolated or FM approved shunt zener diode barriers with linear outputs, used channel to channel and having entity parameters such that $6.7Vdc \leq V_{Ocs} \leq V_{max}$; $I_{sc} \leq I_{max}$; $C_a \geq C_i + C_{cable}$; $L_a \geq L_i + L_{cable}$.
- For Cable and Lcable, if the capacitance per foot or the inductance per foot is not known, then the following values shall be used:
Cable = 60pF/foot and Lcable = 0.2uH/foot.
- For Cable and Lcable, if the capacitance per foot or the inductance per foot is not known, then the following values shall be used:
Cable = 20pF/foot and Lcable = 0.66uH/foot.
- For Cable and Lcable, if the capacitance per foot or the inductance per foot is not known, then the following values shall be used:
Cable = 20pF/foot and Lcable = 0.66uH/foot.
- For Cable and Lcable, if the capacitance per foot or the inductance per foot is not known, then the following values shall be used:
Cable = 20pF/foot and Lcable = 0.66uH/foot.

Installation should be in accordance with the barrier manufacturer's control drawing and Article 504 of the National Electrical Code (ANSI/NFPA 70) and the National Electrical Code (ANSI/NFPA 70).

Notes for installation in European Community:

- EX ia IIB T6; ATEX Certificate No. XXXX; 27.8Vdc; $I_i = 100mA$; $P_i = 695mW$; $C_i = 0.656\mu F$; $L_i = 0mH$.
- Selected Barriers must be galvanically isolated or shunt zener diode barriers with linear outputs used channel to channel and having entity parameters such that $U_{0i} \leq U_i$; $I_{0i} \leq I_i$; $C_{0i} \geq C_i + C_{cable}$; $L_{0i} \geq L_i + L_{cable}$.
- For Cable and Lcable, if the capacitance per foot or the inductance per foot is not known, then the following values shall be used:
Cable = 20pF/foot and Lcable = 0.66uH/foot.
- The wiring of the intrinsically safe circuit may be installed in accordance with EN60079-14 or according to national installation requirements.

General Notes:

Resistance between Intrinsically Safe Ground and earth ground must be less than 1.0 Ohm
Dust-tight conduit seal must be used when installed in Class II and Class III environments.
WARNING - Substitution of components may impair Intrinsic Safety.
WARNING - To prevent fire or combustible atmospheres, disconnect power before servicing.

No revision to drawing without prior FM and NEMKO approval.

TOLERANCES:	XENTAUR Corporation 84F HORSEBLOCK RD, YAPHANK, NY 11980	
Decimal X ± = (30)	Control Drawing	
XX ± = - .010	for Entity Concept/Approved Installation	
.XXX ± = - .005	of Xentaur HDT-series Di-wound Transmitter	
Angular = - 1 deg.	connected to Associated Apparatus,	
Do Not Scale Drawing.	in Hazardous (Classified) Locations	
Material & Finish: (see Notes)	SIZE A	Rev. 2
Drawn: B.B.	Scale: N/A	Date: 11/21/03
		Sheet 2 of 3

DECLARATION OF CONFORMITY



We declare under our sole responsibility that the following products:

Xentaur dewpoint sensors series XTR to which this declaration relates, are in conformity with the protection requirements of Council Directive: 94/9/EC (ATEX Directive) on the approximation of the laws of the Member States concerning equipment and protective systems intended for use in potentially explosive atmospheres, and 89/336/EEC (EMC Directive) as amended by 92/31/EEC and 93/68/EEC on the approximation of the laws of the Member States relating to Electromagnetic Compatibility.

The models covered by this Declaration and evidence of conformity with the ATEX Directive are Xentaur XTR series dewpoint sensors.

Conformity to the ATEX Directive is in accordance with the following European standards.

EN 50014-1997E incl. A1+A2 Electrical Apparatus for Potentially Explosive Atmospheres - General Requirements

EN 50020-2002 Electrical Apparatus for Potentially Explosive Atmospheres - Intrinsic Safety "i"

EN 50284-1999 Special Requirements for Construction, Test and Marking of Electrical Apparatus of Equipment

Group II, Category 1 G

Certificate	Notified Body	Protection	Description
NEMKO 05 ATEX 0505798X	Factory Mutual NEMKO	EEx ia IIC, T6	Xentaur XTR series dewpoint sensors and HDT transmitter.

The authorized signatory to this declaration, on behalf of the manufacturer, and the Responsible Person is identified below.

Xentaur Corporation
84F Horseblock Road
Yaphank, NY 11980 USA
manufacturing location

Bedros Bedrossian
Standards & Approvals Engineer,
Issue Date: 21 March 2005

Appendix G: Current vs. Dewpoint

The current being drawn by the HDT, varies with the dewpoint being measured by the HDT. To use the current to calculate the value of the dewpoint measurement, one must know the settings of the low and high ends of the analog output range, then:

$$D = \frac{(I - 4) \times (H - L)}{16} + L$$

where: I = current drawn by HDT loop in mA.
 H = value of High end of Analog Output range converted to selected engineering units
 L = value of Low end of Analog Output range converted to selected engineering units
 D = dewpoint measured by instrument in selected engineering units.

A HART communicator is required to check and set the Analog Output low and high ranges; the factory default settings are -100°C and +20°C respectively.

For example a unit with factory default settings, drawing 12mA is computed to be measuring a dewpoint of -40°C:

$$\frac{(12 - 4) \times (20 - (-100))}{16} + (-100) = -40$$

Note that the computation is such that the current is linear to the selected engineering units. Hence, ordering a HDT with ppmV or LBS or G/M3 units, will cause the analog output to be linearly proportional to those units (approximately logarithmically proportional to dewpoint), refer to the graph that follows. Naturally selecting °C or °F will cause the analog output to be linearly proportional to dewpoint.

When monitoring in ppmV or LBS or G/M3, the analog output low & high ranges may have to be adjusted to pro-

vide a useful output. Consider an example where the area of interest to be monitored is 10 to 100 ppmV, and the analog output is set up with the factory defaults of -100°C to $+20^{\circ}\text{C}$ (which is 0.014 to 23612 ppmV); then the current loop output will vary only from ~ 4.1 to ~ 4.2 mA in the area of interest (consult with the graph on the following page). In most instances this would be an unacceptable output for proper monitoring of the measurement. In this example the user should adjust the analog output low & high ranges such that the output range is better suited to the measurement of 10 to 100 ppmV. It may be useful to select the low and high ranges to be 5 and 150 ppmV respectively, thus out of range conditions will be detected properly. Then the low range will be set to 5ppmV which is -65.5°C dewpoint, and the high range will be set to 150ppmV which is -38.5°C dewpoint. Now the current loop output will be 4.55 to 14.48 mA in the range of 10 to 100 ppmV, the $\sim 10\text{mA}$ variation is more than sufficient for a good measurement by the user's equipment. One may carry out similar calculations for LBS or G/M3 and choose the appropriate settings. While making these computations it may be useful to obtain a copy of Xentaur's dewpoint calculator, this is a Microsoft WindowsTM program which simplifies the process of converting dewpoint measurement units. It is available at www.xentaur.com. If you are not certain how to carry out such calculations send, by e-mail to xentaur@xentaur.com or by fax to (516) 345-5349, your system specifics, and some one will get back to you with appropriate analog output settings.

In general, if the dewpoint is monitored in $^{\circ}\text{C}$ or $^{\circ}\text{F}$, there is no need to change the factory default -100°C to $+20^{\circ}\text{C}$ settings, because the 4-20mA provides sufficient resolution to measure the output better than the specified accuracy of the sensor.

Relationship of 4-20mA output and instrument reading in ppmV or LBS

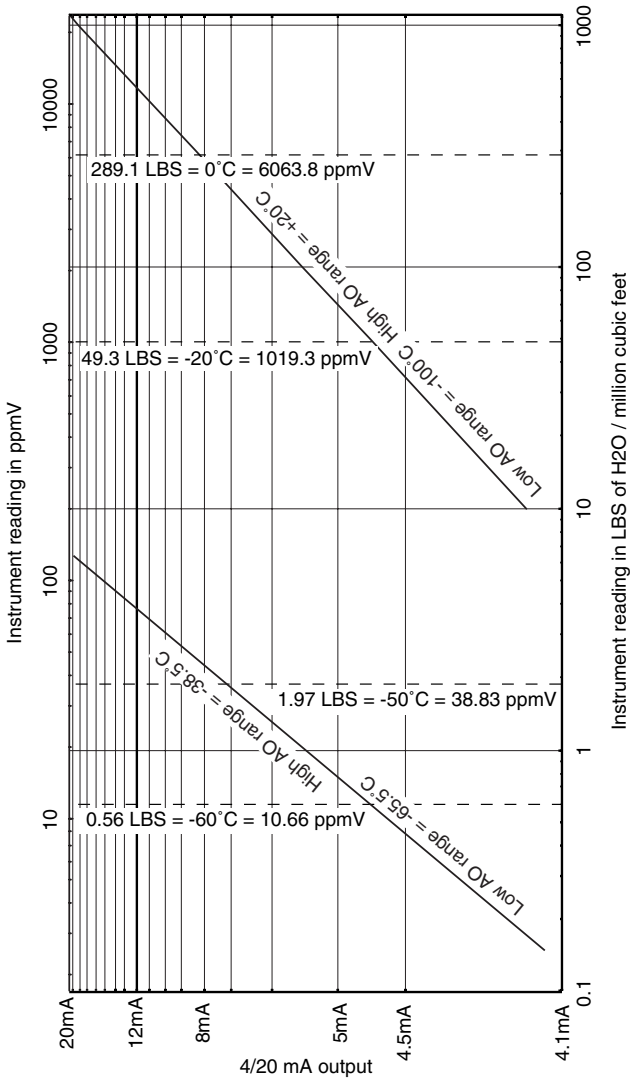

Appendix H: Uncertainty in LBS & ppmV calculations

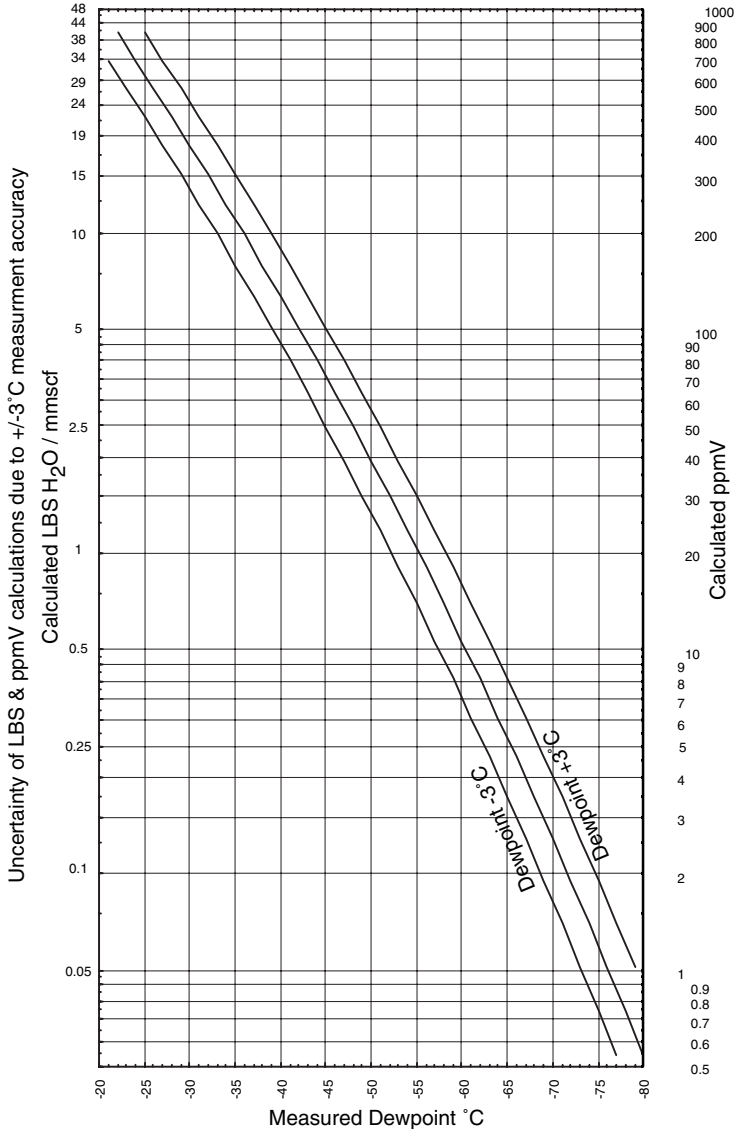

Appendix I: Sensor Response Time

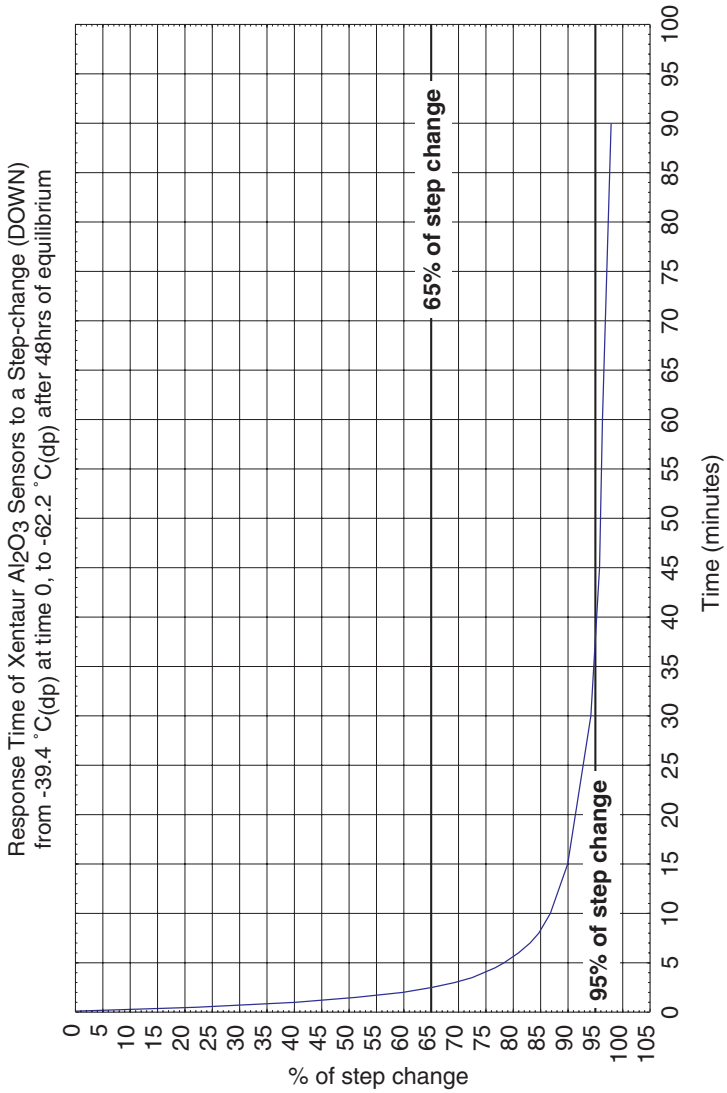

Appendix J: Return Authorization Request

Xentaur must approve and assign a return authorization number (RAN) to any instrument being returned. The RAN must appear on all paperwork and packaging. The issuance of a RAN does not automatically imply that the instrument is covered by our warranty.

In order to serve you better and protect our employees from any potentially hazardous contaminants Xentaur must return unopened at the senders expense all items that do not have a RAN.

To obtain a RAN fill out a copy of this form and fax to (631) 345-5349.

Customer Information

Company Name: _____ Address: _____

Contact Name: _____

Phone: _____

Fax: _____

Equipment Information

Part or model number: **HDT** _____ Serial number: _____

Original Purchase date: _____ P.O. number: _____

Reason for return, failure and hookup description if applicable:

Process material(s) and/or environments (including radiation) to which the equipment has been exposed:

OSHA Hazard Communication Standard 29CFR 1910.1200 mandated that we take specific steps to protect our employees from exposure to potential hazards. Therefore, a letter certifying that the equipment has been decontaminated must accompany all equipment exposed to hazardous contamination.



Xentaur Corporation, 84 Horseblock Road, Yaphank, NY 11980 USA Tel: (631) 345-3434