

Installation & Maintenance Instructions

RHE 42

Coriolis transmitter User Manual



Supplied by

247able.com

Call us on +44 (0)118 916 9420 | Email info@247able.com

RHEONIK.



RHE 42 Coriolis transmitter User Manual

GET FLOW MEASURED



Rheonik Messtechnik GmbH
Rudolf-Diesel-Straße 5
D-85235 Odelzhausen
Germany

Tel + 49 (0)8134 9341-0
info@rheonik.com

LEARN
MORE



Document No.: BA02RHE42202207
Version 04
November 2023

Foreword

This installation guide contains important information regarding how to install, start up, and safely operate the RHE42 Coriolis transmitter as intended together with an RHM Coriolis sensor. The German version of the installation guide is the original installation guide. It supplements the information provided in the RHE 40 desktop reference. The RHE 40 desktop reference and further information are available to download from the Rheonik Messtechnik GmbH website: ➔ <https://rheonik.com>.

Copyright

This installation guide is protected by copyright law. Any use that goes beyond the strict limits set by copyright law is forbidden and liable for prosecution without the prior consent of Rheonik Messtechnik GmbH. This also applies to any reproduction, translation and microfilming in addition to saving and editing in electronic media. Any infringements will be liable for compensation!

Disclaimer

Rheonik Messtechnik GmbH accepts no liability for personal injury, damage to property or accidents caused by the following:

- Failure to observe the installation guide
- Failure to observe the safety regulations
- Using the RHE42 Coriolis transmitter in an impermissible manner

Liability

Claims for compensation against Rheonik Messtechnik GmbH arising due to a breach of pre-contractual or contractual obligations or tortious acts shall exist only in the case of intent or gross negligence on the part of the seller, their representatives or vicarious agents.

If Rheonik Messtechnik GmbH breaches essential contractual obligations due to gross negligence, the extent of the liability shall be restricted to the typically foreseeable loss. If performance is impossible or in the case of default, the claims for compensation shall be restricted to reimbursement of the typically foreseeable loss. If a vicarious agent of Rheonik Messtechnik GmbH acts in a grossly negligent manner, Rheonik Messtechnik GmbH shall be liable to the extent of the typically foreseeable loss. The liability in the case of a breach of essential contractual obligations and in the case of fraudulent intent on the part of the seller remains unaffected by this. In the case of physical injury or damage to well-being and health, the applicable statutory regulations shall apply.

Other applicable documents

The following documents contain additional information regarding how to operate the RHE42 Coriolis transmitter:

- RHE 40 desktop reference (operation manual)
- RHEComPro User Manual (operation manual)
- RHE 40 HART Manual (operation manual)
- RHE20/40 Addendum PID Controller (operation manual)
- RHE40 Addendum Data Logging (operation manual)
- RHE40 Addendum Precision Flow Analysis (operation manual)
- RHE40 Addendum Statistics (operation manual)
- RHE16/20/40 Modbus Map (list of Modbus registers)
- RHM Coriolis sensor (operation manual)

The documents are available to download from the Rheonik Messtechnik GmbH website: ➔ <http://rheonik.com>.

Table of contents

1	About this guide.	7
1.1	General information.	7
1.2	Target group.	7
1.3	Storage.	7
1.4	Declaration of Conformity.	7
1.5	Symbols used in this guide.	8
2	Safety.	9
2.1	How warnings are structured and what they mean.	10
2.2	Safety and associated safety measures.	11
2.3	Personnel qualifications.	12
3	Intended use.	13
3.1	Intended use RHE42.	13
3.2	Impermissible use.	13
4	Product description.	15
4.1	Model code.	18
4.2	Protection classes and safety areas (explosion protection).	20
5	Transportation, storage, scope of delivery.	21
6	Installing the RHE42 Coriolis transmitter.	23
6.1	Installing the RHE42 Coriolis transmitter onto a wall or mounting plate (RHE42-R*).	23
6.2	Installing the RHE42 Coriolis transmitter on a pipe (RHE42-R*).	25
7	Connecting the RHE42 Coriolis transmitter.	26
7.1	Connecting the RHE42 Coriolis transmitter to the RHM Coriolis sensor (RHE42-R*).	26
7.2	Connecting the power supply, inputs/outputs and signal cables to on the RHE42 Coriolis transmitter.	31
7.3	Wiring diagrams for the power supply, RS485 and Modbus TCP.	37
7.3.1	Connecting the power supply.	37
7.3.2	Connecting the RS485 interface.	37
7.3.3	Connecting the Modbus TCP interface.	39
7.3.4	Connecting the Foundation Fieldbus / Profibus interface.	40
7.4	Wiring diagrams for non-intrinsically safe inputs and outputs.	41
7.4.1	Connecting non-intrinsically safe analogue outputs.	41
7.4.2	Connecting non-intrinsically safe digital outputs.	42
7.4.3	Connecting non-intrinsically safe digital inputs.	43
7.4.4	Connecting a non-intrinsically safe HART interface.	44

7.5	Wiring diagrams for intrinsically safe inputs and outputs.	45
7.5.1	Connecting intrinsically safe analogue outputs.	45
7.5.2	Connecting intrinsically safe digital outputs.	46
7.5.3	Connecting intrinsically safe digital inputs.	46
7.5.4	Connecting an intrinsically safe HART interface.	47
8	Start-up.	49
8.1	Function of the keys on the RHE42 Coriolis transmitter. .	49
8.2	Operation.	51
8.3	Initial start-up.	53
8.3.1	Calibrating the zero point.	54
8.3.2	Changing the flow direction.	56
8.3.3	Reading out the IP address.	58
8.3.4	Setting up the RS485 interface.	59
8.3.5	Setting the units of measurement.	61
8.3.6	Configuring analogue outputs.	63
8.3.7	Configuring digital outputs.	66
8.3.8	Configuring digital inputs.	69
8.3.9	Performing an output test.	72
9	Operation, operating modes, using the device.	75
9.1	Resetting the mass flow and volume meters.	75
9.2	Adjusting the display settings.	76
9.3	Setting the filter.	78
10	Servicing, maintenance.	81
10.1	Reading out the Assurance Factor and displaying the Assurance View.	81
10.2	Reading out the zero point.	82
11	Displaying errors.	85
12	Technical data.	91
13	Returns and disposal.	93
14	Appendix A: Ex-Safety Instructions (product approval information).	95
15	Appendices.	105

1 About this guide

1.1 General information

This installation guide contains important information regarding how to install, start up, and safely operate the RHE42 Coriolis transmitter as intended. Carefully read the information in this installation guide before starting any work with or on the RHE42 Coriolis transmitter, and make sure you have understood everything.

1. ► Please familiarise yourself with the information in this installation guide.
2. ► Observe the safety instructions and warnings in this installation guide.

1.2 Target group

This installation guide is aimed at operating personnel and at anyone who has been tasked with the installation and start-up work by the operating personnel.

1.3 Storage





This installation guide is an essential part of the RHE42 Coriolis transmitter and must be stored such that it remains accessible to personnel at all times.

1.4 Declaration of Conformity

The versions of the RHE42 Coriolis transmitter described in this installation guide comply with the applicable standards and guidelines/directives.

1.5 Symbols used in this guide

In this installation guide, sections containing particularly important information are identified in line with the type of information they contain, e.g. instructions, lists or references.

Symbol	Meaning
	Instruction; step in a process If you need to perform several steps one after the other, they will be numbered based on their chronological sequence. Instructions that consist solely of a single step are not numbered.
	Result; outcome of a step
	Lists of entries in no particular order
	References to figures, sections and chapters



This symbol indicates useful additional information.

2 Safety

To ensure that the RHE42 Coriolis transmitter is operated safely and as intended, it is essential to familiarise yourself with the basic safety instructions and safety regulations. It is also essential to comply with the rules and regulations on accident prevention that apply at the installation location.

This installation guide contains important information regarding how to safely operate the RHE42 Coriolis transmitter as intended. Carefully read the information in this installation guide before starting any work with or on the RHE42 Coriolis transmitter, and make sure you have understood everything.

2.1 How warnings are structured and what they mean

When performing different types of work either with the or on the RHE42 Coriolis transmitter, the personnel carry out steps that could entail hazards. These steps are therefore preceded by a warning.

Warnings are always structured as follows:

- Warning symbol
- Signal word:
 - **DANGER**
 - **WARNING**
 - **CAUTION**
 - **ATTENTION**
- Description of the type of hazard and how it arises
- Description of the potential consequences of disregarding the hazard
- Description of measures for preventing the hazard

DANGER: Hazard with a high risk and that will result in death or serious injury if not prevented.

	DANGER
	<p>Type of hazard and how it arises!</p> <p>Potential consequence(s) of disregarding the hazard.</p> <ul style="list-style-type: none"> - List of measures for preventing the hazard

WARNING: Hazard with a moderate risk and that may result in death or serious injury if not prevented.

	WARNING
	<p>Type of hazard and how it arises!</p> <p>Potential consequence(s) of disregarding the hazard.</p> <ul style="list-style-type: none"> - List of measures for preventing the hazard



CAUTION: Hazard with a low risk and that may result in slight or moderate injury if not prevented.

	CAUTION
	<p>Type of hazard and how it arises!</p> <p>Potential consequence(s) of disregarding the hazard.</p> <ul style="list-style-type: none"> - List of measures for preventing the hazard

ATTENTION (NOTE): Risk of damage to property if information is not observed.

	NOTICE
	<p>Type of hazard and how it arises!</p> <p>Potential consequence(s) of disregarding the hazard.</p> <ul style="list-style-type: none"> - List of measures for preventing the hazard

2.2 Safety and associated safety measures

	<p>DANGER</p> <p>Risk to life if the information in this installation guide is not observed!</p> <p>If the information in this installation guide is not observed, this will result in serious injury or death.</p> <ul style="list-style-type: none"> – Read and observe the information in this installation guide before working either with the or on the RHE42 Coriolis transmitter. – Take the safety instructions and warnings seriously and follow the measures for preventing the hazard. – Work carefully in order to prevent accidents resulting in personal injury or damage to property. – Keep the installation guide safe and make it available to anyone working either with the or on the RHE42 Coriolis transmitter.
	<p>DANGER</p> <p>Risk to life due to explosive dust and gas atmospheres igniting!</p> <p>When working in hazardous areas there is a risk that explosive dust and gas atmospheres will be ignited by sparks or naked flames.</p> <ul style="list-style-type: none"> – Have work in hazardous areas performed only by trained and instructed specialist personnel. – Observe any country-specific guidelines that apply to work performed in hazardous areas.

For your safety

■ Explosion protection in areas with explosive dust and gas atmospheres

Explosive dust and gas atmospheres can cause major explosions and fire.

- Please observe the information concerning explosion protection in Appendix A, see: ➔ [Chapter 14 'Appendix A: Ex-Safety Instructions \(product approval information\)' on page 95.](#)
- In hazardous areas, only use the RHE42 Coriolis transmitter in conjunction with intrinsically safe RHM Coriolis sensors. The classification can be found on the type label on the RHM Coriolis sensor.
- The RHE42 Coriolis transmitter must be installed and maintained in accordance with the applicable standards governing electrical installations in hazardous areas.
- The connecting cable (ARHE-Cx) between the RHM Coriolis sensor and RHE42 Coriolis transmitter is intrinsically safe.
- The connecting cable (ARHE-Cx) must not exceed 20 m in length.
- The connecting cable (ARHE-Cx) has been specified for a temperature range of -50 to +105°C. Avoid any temperatures higher than this. Temperatures of below -50°C are permitted if the connecting cable (ARHE-Cx) has been routed in a protective conduit.

- If the RHE42 Coriolis transmitter has been installed in a hazardous area, do not open it whilst it is energised.
- Observe all national regulations governing how to install, maintain and repair instruments located in hazardous areas.
- **Modifications, attachments and conversions**
Any modifications to or attachments and conversions on the RHE42 Coriolis transmitter may make the safety devices less effective or entirely ineffective, resulting in unforeseeable hazards.
 - Do not carry out any technical modifications or extensions on the RHE42 Coriolis transmitter.
- **Risk of injury from slipping, tripping or falling when carrying out installation work!**
There is a risk of serious injury from slipping on or tripping over electrical cables, supply lines, and tools that are lying around.
 - Make sure that nobody could trip over or fall as a result of the electrical cables when carrying out installation work.
 - Route electrical cables and supply lines such that nobody could slip on or trip over them and fall.

2.3 Personnel qualifications

	NOTICE
	<p>Damage to property due to inadequately qualified personnel!</p> <p>All electrical work must only be performed by people who have in-depth expertise in electrical engineering (e.g. qualified electricians). These individuals must provide evidence that they have the requisite expertise for performing work on electrical systems and the associated components (e.g. by having passed an examination) and have been trained on the specific product(s) in question.</p> <p>Mechanical work must only be performed by appropriately qualified and trained personnel.</p>

Task	Party responsible	Qualification
Installation work	Operating personnel	Engineer
Work on the electrical system	Operating personnel	Qualified electrician
Initial start-up, configuration of parameters	Operating personnel	Engineer
Dismantling work	Operating personnel	Engineer
Disposal	Specialist waste disposal company	Expert specialists who have received specific training

Tab. 1: Personnel qualifications

3 Intended use

Rheonik Coriolis mass flow measuring instruments consisting of a sensor (RHM), a transmitter (RHE), and in some cases, an interconnecting cable, are intended for measuring liquids and gases. The operator must ensure that the instrument is only used in a way that complies with limitations and certifications listed on the instrument type plates. These limitations/certifications include, but are not limited to:

- Pressure and temperature ranges
- Approval limits (e.g., explosion protection, pressure equipment directive)
- Suitability of the materials of construction in contact with the process

The instrument must be installed, operated, and maintained in accordance with the manufacturer's instructions and guidelines. The instrument must not be modified or altered in any way that has not been approved by the manufacturer or certification body. Regular inspections and preventive maintenance should be carried out to ensure ongoing safety and performance. Use not in accordance with the intended purpose may impair and/or endanger safety.

3.1 Intended use RHE42

The RHE42 Coriolis transmitter displays the measured values for RHM Coriolis sensors. It can display the mass flow of liquids and gases as well as the medium density and medium temperature. In addition, the RHE42 Coriolis transmitter is able to calculate variables such as the volume.

Only install and operate the RHE42 Coriolis transmitter in locations with the following ambient conditions:

- Ambient temperature -20 to +60 °C (optionally -40 to +65 °C), see specification on type label: *Fig. 3*
- Altitude of max. 3000 m above sea level
- Relative humidity of 10 to 95% (non-condensing)
- In shade; not exposed to direct sunlight

3.2 Impermissible use

The following are examples of impermissible use of the RHE42 Coriolis transmitter (i.e. use contrary to its intended use):

- Using the RHE42 Coriolis transmitter in locations other than those specified above.
- Using the device in life-support systems in the medical, motor vehicle, aircraft, water craft or mining industries.

4 Product description

**RHE42-C* Coriolis transmitter
(compact version RHE42 Coriolis transmitter installed on RHM Coriolis sensor)**

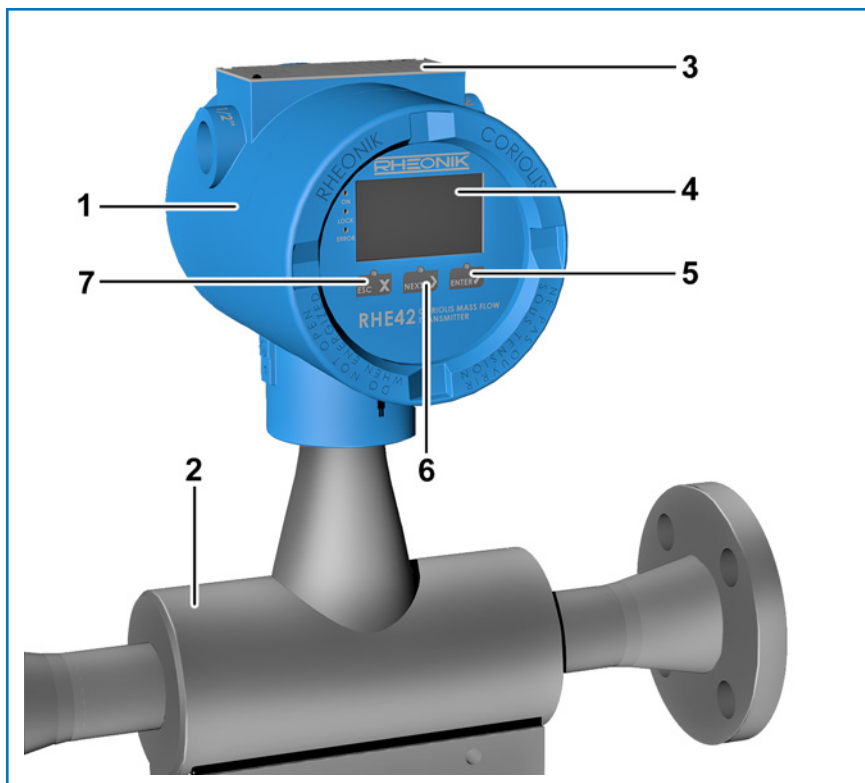





Fig. 1: RHE42 Coriolis transmitter with RHM Coriolis sensor

- 1 RHE42 Coriolis transmitter
- 2 RHM Coriolis sensor
- 3 Type label
- 4 Display
- 5  key
- 6  key
- 7  key

RHE42-R* Coriolis transmitter (remote installation)

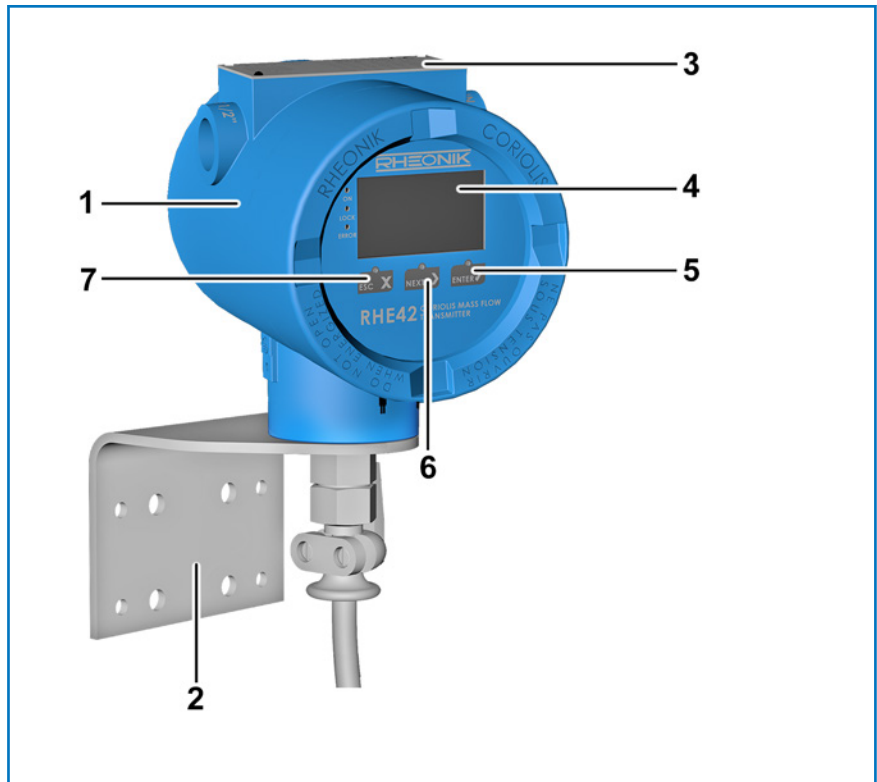





Fig. 2: RHE42 Coriolis transmitter with bracket for installation on the wall

- 1 RHE42 Coriolis transmitter
- 2 Installation angle for installation on the wall or a pipe
- 3 Type label
- 4 Display
- 5  key
- 6  key
- 7  key

Type label

1 RHEONIK. CE 0044 Rheonik Messtechnik GmbH Germany, 85235 Odelzhausen		2 Pins		3 U ₀ (V)		I ₀ (mA)		P ₀ (mW)		L ₀ (mH)		C ₀ (nF)	
A Coriolis Transmitter B RHE42 E42-RDD1-SOFF-A1NN-NNN		Drv	1-2	8.1	136	275	1.9 ¹⁾	2000					
Ser. No.: C RHE-123456		PU	6-7, 9-8	2.4	9.0	5.4	100	2000					
TAG No.: D FT 0815 A		Temp	3-4, 5-4	6.5	43.8	71.2	1	2000					
Supply DC: E 12...24V ±10% / DC / 4W		Um for non-IS Circuits		30V									
Ambient: Prot: F -20°C ≤ Ta ≤ +60°C G IP65		I/O	Pins	U _i (V)	I _i (mA)	P _i (mW)	L _i (mH)	C _i (nF)					
Set for: H RHM-123456		AO	51-52, 53-54	30	100	750	0.1	negli.					
I  J BVS 21ATEX E 091 X		DO	40-41, 42-43	30	50	375	negli.negli.						
K Ex db eb [ia Ga] IIC T4 Gb L IECEx BVS 21.0093X		FF ²⁾	77-78	FISCO field device									

Fig. 3: Type label

- 1 Type label
- 2 CE for conformity / CSA for approval
- 3 Table with safety limits for the intrinsically safe inputs and outputs
- A Product designation
- B Model code
- C Serial number

- D Customer-specific tag number RHM Coriolis sensor
- E Permissible power supply
- F Permissible ambient temperature
- G Housing classification
- H Serial number of corresponding sensors RHM
- I ATEX classification / CSA Zone marking USA
- J ATEX certificate number / CSA Zone marking Canada
- K IECEx classification / CSA Division marking
- L IECEx certificate number / CSA certificate number

Abbrevia- tion	Name
DRV	Sensor drive
PU	Pick-up of measured values
TE	Temperature measurement
AO	Analogue output
DO	Digital output
DI	Digital input
U ₀	Maximum output voltage
I ₀	Maximum output current
P ₀	Maximum output power
L ₀	Maximum external inductance
C ₀	Maximum external capacitance
U _i	Maximum input voltage
I _i	Maximum input current
P _i	Maximum input power
L _i	Maximum internal inductance
C _i	Maximum internal capacitance
FF	FISCO field device Foundation Fieldbus

Tab. 2: Abbreviations on the type label

System information

A Coriolis flow meter or a Coriolis flow meter for hazardous areas (optional) consists of the following components:

- RHM Coriolis sensor
- RHE42 Coriolis transmitter with built-in barrier
- Connecting cable (ARHE-Cx) (already installed on the RHE42 Coriolis transmitter ex works) (only for the RHE42-R* versions)

The RHM Coriolis sensors are optionally available as intrinsically safe versions. They can be installed in zone 0, 1 or 2, as well as in 20, 21 or 22, depending on their certification. Versions suitable for Div. 1 and

2 are available for the American market. Detailed information on the protection classes and safety areas is provided here: [↔ Chapter 4.2 'Protection classes and safety areas \(explosion protection\)' on page 20.](#)

4.1 Model code

	RHE42-	xx	D1-	xx	xx	xx	xx	xxx
Housing IP65/Type 4 (indoor and outdoor use) with								
■ 3 m connecting cable (ARHE-Cx) and no "Human-Machine Interface" (HMI) display and input device	RB							
■ 10 m connecting cable (ARHE-Cx) and no HMI	RC							
■ 3 m connecting cable (ARHE-Cx) and with HMI	RD							
■ 10 m connecting cable (ARHE-Cx) and with HMI	RE							
Housing IP65/Type 4 (installed directly on the RHM Coriolis sensor)								
■ No HMI	C1							
■ With HMI	CD							
Power supply								
12 – 24 V DC ±10%			D1					
Software package								
■ Advanced diagnostic package (Assurance Factor)				AF				
■ Package for legal metrology				CT				
■ Multi-functional measurement package				DO				
■ Package for the fastest signal processing				FR				
■ Oil and gas function package				OG				
■ Mass flow measurement package				SO				
Digital inputs and digital/analogue outputs (not intrinsically safe)								
■ Analogue outp. (a/p) 1x, dig. outp. 2x, dig. inp. 1x, RS 485 (Modbus), HART communication					1H			
■ Dig. outp. 2x, dig. inp. 2x, RS 485 (Modbus)					B1			
■ Analogue outp. (a/p) 1x, dig. outp. 2x, dig. inp. 1x, RS 485 (Modbus), Modbus TCP/IPv4, HART communication					EA			
■ Dig. outp. 2x, dig. inp. 2x, RS 485 (Modbus), Modbus TCP/IPv4					EB			
■ Analogue outp. (a/p) 1x, dig. outp. 2x, dig. inp. 1x, RS 485 (Modbus)					S1			
■ Analogue outp. (a/p) 2x, dig. outp. 2x, RS 485 (Modbus), HART communication					S2			

	RHE42-	xx	D1-	xx	xx	xx	xx	xxx
Digital inputs and digital/analogue outputs (intrinsically safe)								
■ Analogue outp. (p) 1x, dig. outp. 2x, HART communication, RS 485 (Modbus – not intrinsically safe)					i1			
■ Analogue outp. (p) 2x, dig. outp. 1x, dig. inp. 1x, HART communication, RS 485 (Modbus – not intrinsically safe)					i2			
■ Foundation Fieldbus FFH1 (FISCO), analogue outp. (p) 1x, dig. outp. 1x, RS 485 (Modbus – not intrinsically safe)					F2			
■ Foundation Fieldbus FFH1 (FISCO), RS 485 (Modbus – not intrinsically safe)					FF			
■ Profibus PA, RS 485 (Modbus – not intrinsically safe)					PA			
■ Profibus PA, analogue outp. (p) 1x, dig. outp. 1x, RS 485 (Modbus – not intrinsically safe)					P2			
Explosion protection								
■ ATEX/IECEEx zone 1, 2, gas					A1			
■ ATEX/IECEEx zone 2, gas					A2			
■ ATEX/IECEEx zone 21, 22, dust					AD			
■ ATEX/IECEEx safe area					AS			
■ CSA US-Can. class I, Div 1, 2 / zone 0, 1, 2					C1			
■ CSA US-Can. class I, Div 2 / zone 2					C2			
■ CSA US-Can. class I, Div 1, 2 / class I, zone 20, 21, 22					CD			
■ CSA US-Can. safe area					CS			
Performance certification								
■ None							NN	
■ ABS approval for ship applications							AB	
■ Custody transfer certification OIML-CS R117							R7	
■ Custody transfer certification OIML-CS R139							9R	
Options								
■ None								NNN
■ Improved protection rating IP66-67/Type 6, Ambient temperature -40 – + 65°C.								N67
■ Settings lock switch (included in software package CT and FR)								NNH

Tab. 3: Definition of model code

4.2 Protection classes and safety areas (explosion protection)

Order code	Designation	Area of application for RHE42 Coriolis transmitter	Area of application for RHM Coriolis sensor	Certified according to/by
A1	II 2(1)G Ex db eb [ia Ga] IIC T6 Gb	Zone 1, 2; safe area	Zone 0, 1, 2; safe area	ATEX, IECEx
AA	II 2(1)G Ex db eb [ia Ga] IIB T6 Gb	Zone 1, 2; safe area	Zone 0, 1, 2; safe area	ATEX, IECEx
A2	II 3(1)G Ex db ec [ia Ga] IIC T6 Gc	Zone 2; safe area	Zone 0, 1, 2; safe area	ATEX, IECEx
AB	II 3(1)G Ex db ec [ia Ga] IIB T6 Gb	Zone 2; safe area	Zone 0, 1, 2; safe area	ATEX, IECEx
AD	II 2(1)D Ex tb [ia Da] IIIC T85°C Db	Zone 21, 22; safe area	Zone 20, 21, 22; safe area	ATEX, IECEx
AS	II (1)G [Ex ia Ga] IIC and II (1) D [Ex ia Da] IIIC	Safe area	Zone 0, 1, 2; safe area	ATEX, IECEx
C1	Class I, Div. 1, Group A, B, C & D, T6	Class I; Div 1, 2; safe area / zone 0, 1, 2; safe area	Class I; Div 1, 2; safe area; zone 0, 1, 2; safe area	CSA / ETL
C2	Class I, Div. 2, Group A, B, C & D, T6	Class I; Div 2; safe area / zone 2; safe area	Class I; Div 1, 2; safe area; zone 0, 1, 2; safe area	CSA / ETL
CD	Class II, Div 1, Group E, F and G	Class II; Div 1, 2; safe area; zone 20, 21, 22; safe area	Class II; Div 1, 2; safe area; zone 20, 21, 22; safe area	CSA / ETL
CS	[Ex ia Ga] IIC	Safe area	Class I; Div 1, 2; safe area; zone 0, 1, 2; safe area	CSA / ETL

Tab. 4: Overview of application areas

5 Transportation, storage, scope of delivery

Transportation

- > Always transport the RHE42 Coriolis transmitter in its original packaging.

Storage

- > Store the RHE42 Coriolis transmitter under the following conditions until it is installed:
 - In the original packaging
 - Dust-free, dry and not exposed to direct sunlight
 - Storage temperature of -40 to +65°C

Scope of delivery

- 1.** —> Check the packaging of the RHE42 Coriolis transmitter for any damage.



If the packaging is damaged, immediately inform the freight forwarder and your local sales/support representative.

- 2.** —> Check the contents to make sure all the items you ordered are present.
- 3.** —> Check whether the model code on the type label matches the model code on the order.
- 4.** —> If the device comes with protective caps fitted, only remove these just before you start the installation work.
- 5.** —> Keep the packaging safe in case you need to ship the device at a later date.

6 Installing the RHE42 Coriolis transmitter

There are three ways to install the RHE42 Coriolis transmitter:

- Installed directly on an RHM Coriolis sensor (RHE42-C*) ex works. See: RHM Coriolis sensor (operation manual)
- Installed externally on a wall or on a metal plate that is at least 6 mm thick (RHE42-R*)
- Installed externally on a pipe (RHE42-R*) (this requires accessory ARHE42-H)

6.1 Installing the RHE42 Coriolis transmitter onto a wall or mounting plate (RHE42-R*)

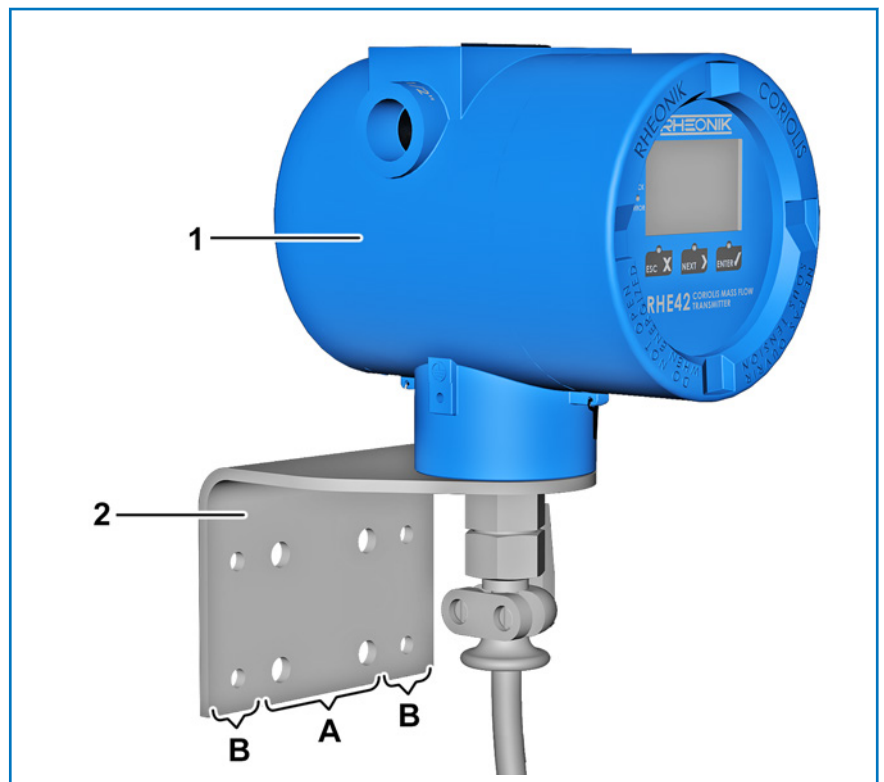

Fig. 4: RHE42-R* with bracket for external installation on a flat surface

- 1 RHE42 Coriolis transmitter (RHE42-R*)
- 2 Installation angle (included in delivery)
- A Mounting holes dia. 9 mm
- B Mounting holes dia. 6.6 mm

- 1.** Position the RHE42 Coriolis transmitter (1) with the installation angle (2) on the wall/mounting plate.
- 2.** Mark the position of the mounting holes (A or B) on the wall/mounting plate.

- 3.** ▶ Remove the RHE42 Coriolis transmitter (1) from the wall/mounting plate.

**NOTICE****Damage to property when drilling holes near components.**

When drilling the holes, there is a risk of damaging components that are located in or next to the wall.

- Before drilling the holes, check the area to see if there are any components, pipes or electrical cables located behind it.

- 4.** ▶ Drill holes of the appropriate diameter for the installation method you are using (installation on a wall or mounting plate).
- 5.** ▶ Select the appropriate installation material for the fastening system you are using from the scope of delivery.
- 6.** ▶ Fasten the RHE42 Coriolis transmitter (1) to the wall/mounting plate.

6.2 Installing the RHE42 Coriolis transmitter on a pipe (RHE42-R*)

This installation method requires the ARHE42-H accessory. The pipe onto which the RHE42 Coriolis transmitter will be installed must be made of metal and have a diameter of at least 2 inches / 50 mm.

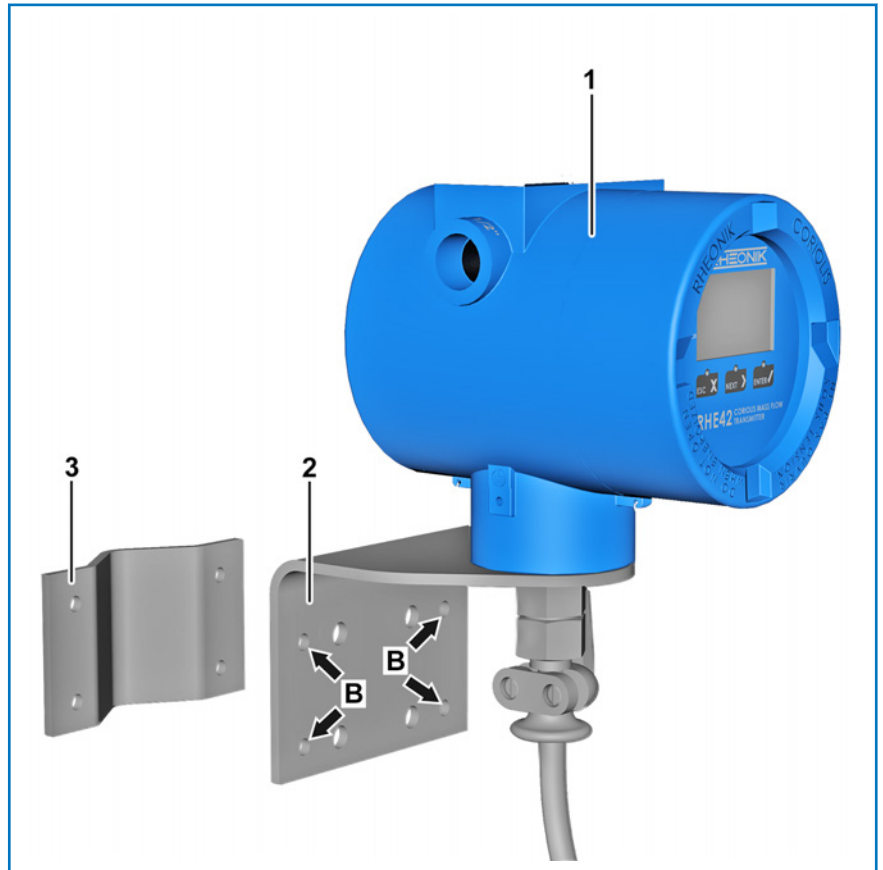



Fig. 5: RHE42-R* with bracket for installation on a pipe

- 1 RHE42 Coriolis transmitter (RHE42-R*)
- 2 Installation angle (included in delivery)
- 3 Counter-bracket (for installation on a pipe)
- B Mounting holes dia. 6.6 mm

- 1.** Position the RHE42 Coriolis transmitter (1) on the pipe.
- 2.** Fasten the RHE42 Coriolis transmitter (1) to the pipe with installation angle (2) using the counter-bracket (3) and the supplied nuts and bolts. Use the mounting holes with dia. 6.6 mm (B) for this purpose.

7 Connecting the RHE42 Coriolis transmitter

	NOTICE
	<p>Damage to property due to ingress of water!</p> <p>Openings on the RHE42 Coriolis transmitter or RHM Coriolis sensor may allow moisture to enter and cause short circuits or corrosion, damaging the components.</p> <ul style="list-style-type: none"> - Once the electrical connections have been installed, seal all unused cable glands and openings using certified dummy plugs. - Ensure that all cable glands have been sealed airtight.

Connection	Terminals		Type	Nominal voltage
	Not intrinsically safe	Intrinsically safe		
DC power supply	20, 21	20, 21	Feed	12 – 24 V DC
Digital outputs	31, 32	40 – 43	Output	24 V
Analogue outputs	51 – 54	51 – 54	Output	24 V
Digital inputs	35, 36	46, 47	Feed	24 V
Fieldbus (FISCO)	-	77 – 78	Interface	-

Tab. 5: Thresholds for the power supply

	NOTICE
	<p>Damage to property due to overvoltage!</p> <p>Any voltages greater than the nominal voltage can damage the RHE42 Coriolis transmitter.</p> <ul style="list-style-type: none"> - When establishing the connection, ensure that the input voltage is not higher than the nominal voltage for the connection in question.

7.1 Connecting the RHE42 Coriolis transmitter to the RHM Coriolis sensor (RHE42-R*)

	<p>Use of connecting cables</p> <p>Use only the connecting cable (ARHE-Cx) that is connected to the RHE42 Coriolis transmitter. If the connecting cable (ARHE-Cx) is damaged, the RHE42 Coriolis transmitter will need to be returned to Rheonik Messtechnik GmbH for repair.</p> <p>The connecting cable (ARHE-Cx) must not be longer than 20 m.</p>
---	---



WARNING

Risk of burns when touching hot surfaces!

If you are using an RHM Coriolis sensor with hot liquids and gases, the RHM Coriolis sensor and adjacent components can become very hot. There is a risk of serious burns if you touch hot surfaces.

- Allow the RHM Coriolis sensor and adjacent components to cool down.
- Avoid direct contact with hot surfaces.

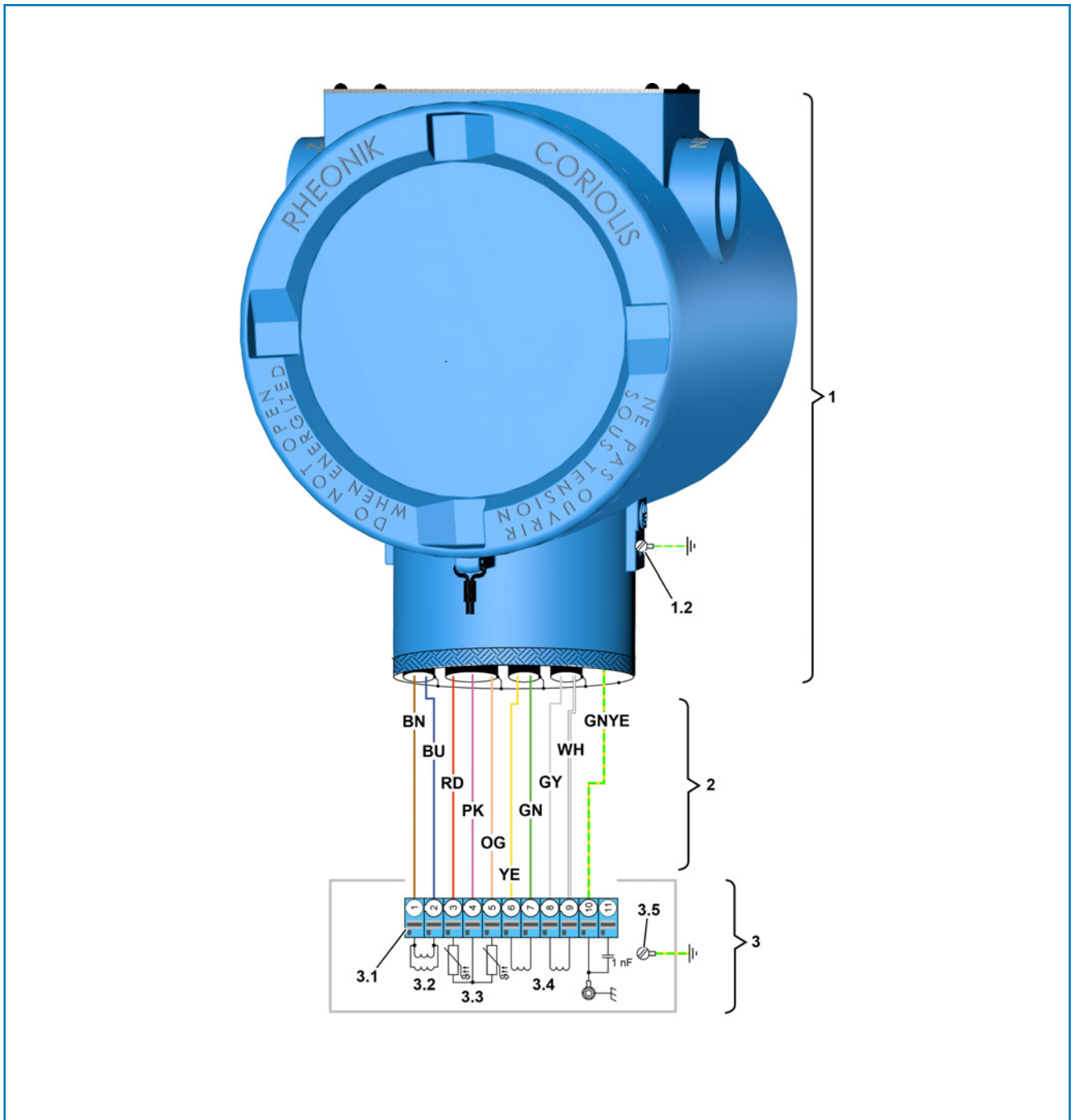

Fig. 6: Wiring diagram for the RHE42-R* Coriolis transmitter to the RHM Coriolis sensor

- | | | | |
|-----|----------------------------|------|--------------------|
| 1 | RHE42 Coriolis transmitter | BU | Blue cable |
| 1.2 | Grounding point | GN | Green cable |
| 2 | Connecting cable (ARHE-Cx) | GNYE | Green/yellow cable |
| 3 | RHM Coriolis sensor | GY | Grey cable |
| 3.1 | Connection terminal | OG | Orange cable |
| 3.2 | Drive coil | PK | Pink cable |
| 3.3 | Temperature sensors | RD | Red cable |
| 3.4 | Pick-up coils | WH | White cable |
| 3.5 | Ground point for housing | YE | Yellow cable |
| BN | Brown cable | | |

1. Check whether the serial number on the type label of the RHE42 Coriolis transmitter (1) matches the serial number of the RHM Coriolis sensor (3) that you are connecting.



The RHE42 Coriolis transmitter is assigned a RHM Coriolis sensor in the factory. The serial number of the corresponding RHM Coriolis sensor is stated on the type label of the RHE42 Coriolis transmitter.

2. Undo the cable gland on the RHM Coriolis sensor (3).
3. Unscrew the fastening screws on the cover of the RHM Coriolis sensor (3) and remove the cover.
4. Guide the connecting cable (ARHE-Cx) (2) through the housing to the connection terminal (3.1).
5. Connect the connecting cable (ARHE-Cx) (2) to the RHM Coriolis sensor (3) in accordance with the wiring diagram; see: [Figure 6](#).



The following measures will provide optimal protection against electromagnetic interference between the RHM Coriolis sensor and RHE42 Coriolis transmitter:

- Connecting the cable shielding to PE (terminal 10).
- Connecting the shielding to PE_C (terminal 11) (on devices that have a longer connecting cable (ARHE-Cx) (2) and small differences in the ground potential).
- Connecting a separate equipotential bonding cable (if there are relatively large differences in the ground potential).



The connection terminals are equipped with push-in terminals. Wires with wire ferrules can be directly inserted. To connect a wire without a wire ferrule or to release a wire, ensure the latch is pressed in as you insert/remove the wire.

6. Route the connecting cable (ARHE-Cx) (2) in the housing of the RHM Coriolis sensor (3) such that it cannot become damaged by being trapped or from tensile forces.
7. Tighten the cable gland on the RHM Coriolis sensor (3).
8. Place the cover onto the housing of the RHM Coriolis sensor (3) and screw in the fastening screws.
9. Secure the connecting cable (ARHE-Cx) (2) with a strain relief fitting.

Cable colour	Signal
BN brown	Drive coil +
BU blue	Drive coil -
RD red	Temperature sensor - pipe

Cable colour	Signal
PK pink	Temperature sensor – ground
OG orange	Temperature sensor – torsion
YE yellow	Pick-up coil (A) left +
GN green	Pick-up coil (A) left -
GY grey	Pick-up coil (B) right +
WH white	Pick-up coil (B) right -
GNYE green/yellow	Shielding
	Shielding

Tab. 6: Overview of signals for connecting cable (ARHE-Cx)

7.2 Connecting the power supply, inputs/outputs and signal cables to on the RHE42 Coriolis transmitter

Assignment when I/O not intrinsically safe

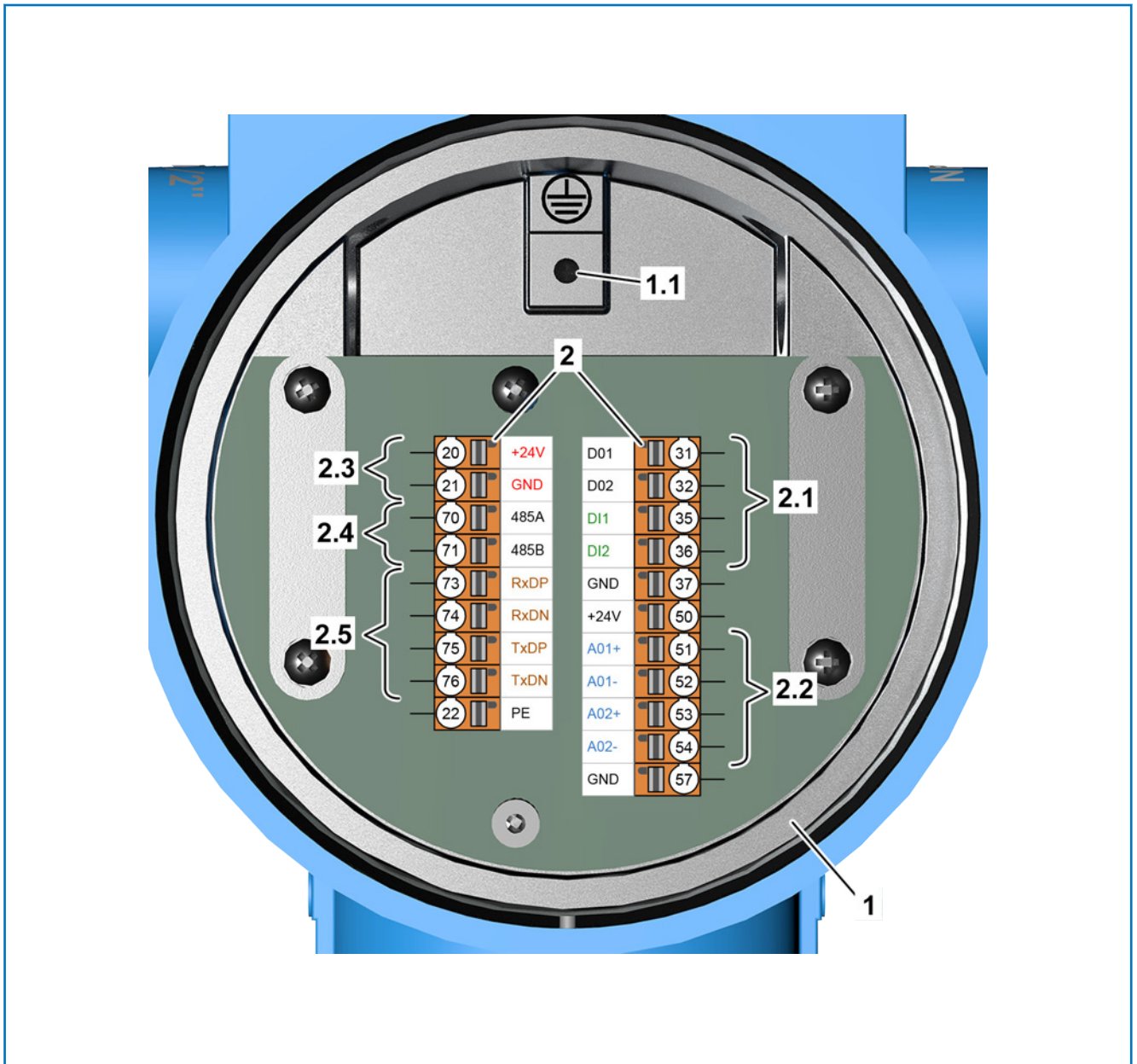

Fig. 7: Wiring diagram for RHE42-R* Coriolis transmitter (not intrinsically safe)

- 1 RHE42 Coriolis transmitter
- 1.1 Ground screw for shielding connection
- 2 Connection terminals
- 2.1 Digital inputs and outputs
- 2.2 Analogue outputs
- 2.3 Power supply for the RHE42 Coriolis transmitter
- 2.4 RS 485 interface
- 2.5 Modbus TCP

Terminal	Signal	Name
20	+24 V	Supply of +24 V
21	GND	Ground
22	PE	Protective conductor

Terminal	Signal	Name
70	485A	RS 485 connection (+)
71	485B	RS 485 connection (-)

Tab. 7: Terminal assignment for RHE42 Coriolis transmitter

Terminal	Signal	Name	Implemented as
31	DO1	Active digital output 1	All
32	DO2	Active digital output 2	All
35	DI1	Passive digital input 1	B1, EB, EA, S1, 1H
36	DI2	Passive digital input 2	B1, EB
37	GND	Ground (digital inputs and outputs)	All
50	+24 V	+24 V analogue outputs	All
51	A01+	Passive analogue output 1 (+) optionally with HART communication	EA, S1, S2, 1H
52	A01-	Passive analogue output 1 (-) optionally with HART communication	EA, S1, S2, 1H
53	A02+	Passive analogue output 2 (+)	S2
54	A02-	Passive analogue output 2 (-)	S2
57	GND	Ground for analogue outputs	All
73	RxDP	Modbus TCP RxD+	EB, EA
74	RxDN	Modbus TCP RxD-	EB, EA
75	TxDP	Modbus TCP TxD+	EB, EA
76	TxDN	Modbus TCP TxD-	EB, EA

Tab. 8: Terminal assignment for RHE42 Coriolis transmitter (not intrinsically safe)

Assignment when I/O intrinsically safe

Intrinsically safe RHE42 Coriolis transmitters must only be used in conjunction with certified barriers/supply isolators. This is the only way to guarantee that the entire electrical circuit is intrinsically safe.

The following inputs/outputs and signal cables must be connected using certified barriers/supply isolators:

- Digital outputs 1 and 2
- Digital input
- Analogue outputs 1 and 2
- Foundation Fieldbus FFH1 (FISCO)
- Profibus PA (FISCO)

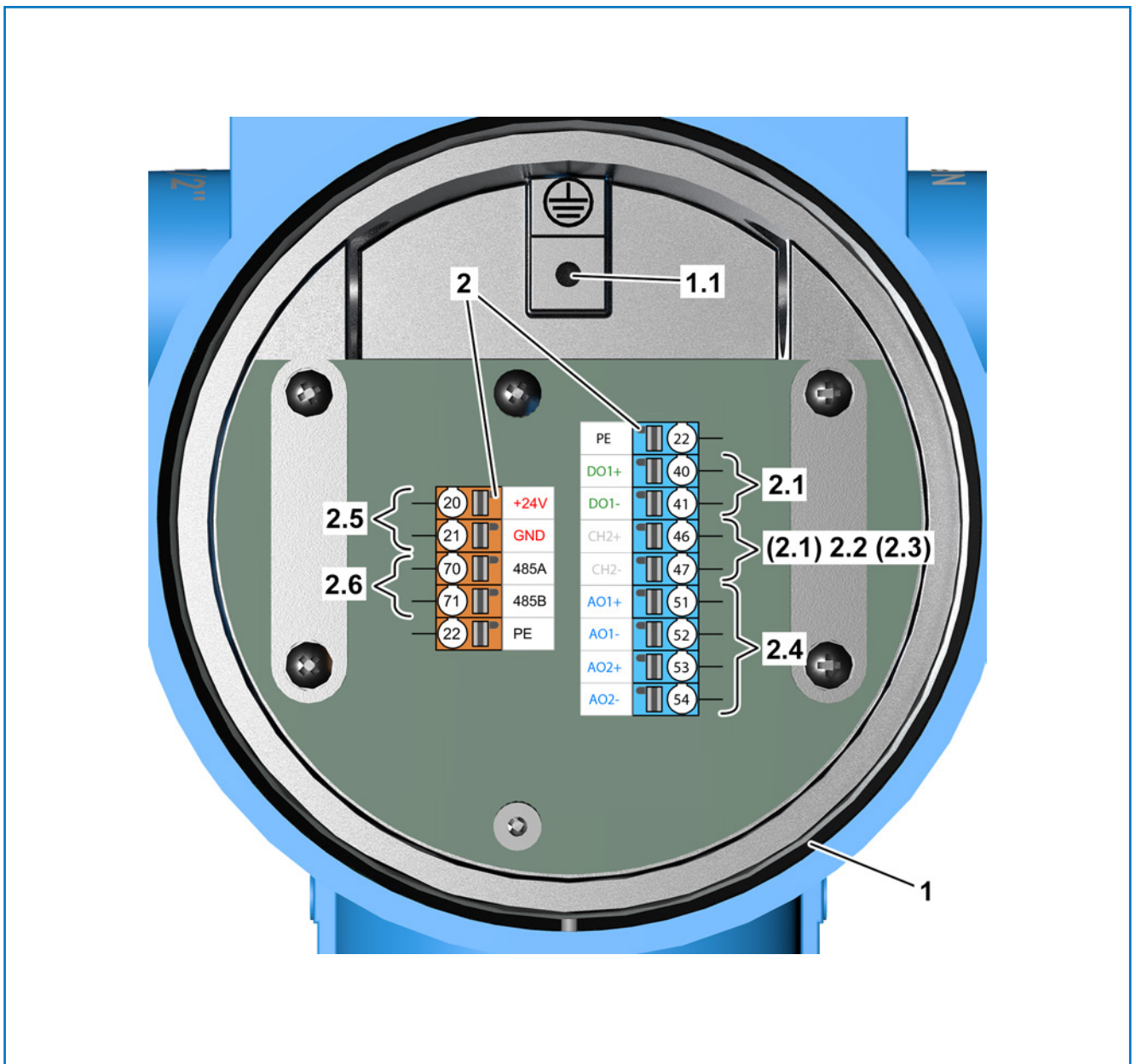

Fig. 8: Wiring diagram for RHE42-R* Coriolis transmitter (intrinsically safe)

- 1 RHE42 Coriolis transmitter
- 1.1 Ground screw for shielding connection
- 2 Connection terminals
- 2.1 Digital outputs (intrinsically safe)
- 2.2 Digital inputs (intrinsically safe)
- 2.3 Fieldbus (intrinsically safe)
- 2.4 Analogue outputs (intrinsically safe)
- 2.5 Power supply for RHE42 Coriolis transmitter (not intrinsically safe)
- 2.6 RS 485 interface (not intrinsically safe)

Terminal	Signal	Name
20	+24 V	Supply of +24 V
21	GND	Ground
22	PE	Protective conductor
70	485A	RS 485 connection (+)

Terminal	Signal	Name
71	485B	RS 485 connection (-)

Tab. 9: Terminal assignment for RHE42 Coriolis transmitter

Channel	Terminal	Signal	Name	Implemented as
1	40	D01+	Digital output 1 (+)	i1, i2, F2, P2
	41	D01-	Digital output 1 (-)	i1, i2, F2, P2
2	42	D02+	Digital output 2 (+)	i1
	43	D02-	Digital output 2 (-)	i1
	46	DI1+	Digital input (+)	i2
	47	DI1-	Digital input (-)	i2
	77	FF+	Foundation Fieldbus FFH1 (FISCO) (+)	FF, F2
		PA+	Profibus PA (FISCO) (+)	PA, P2
	78	FF-	Foundation Fieldbus FFH1 (FISCO) (-)	FF, F2
		PA-	Profibus PA (FISCO) (-)	PA, P2
		CH2+	Not assigned	FF, PA
		CH2-	Not assigned	FF, PA
3	51	A01+	Analogue output 1 (+) optionally with HART communication	i1, i2, F2, P2
	52	A01-	Analogue output 1 (-) optionally with HART communication	i1, i2, F2, P2
4	53	A02+	Analogue output 2 (+)	i2
	54	A01-	Analogue output 2 (-)	i2

Tab. 10: Terminal assignment for RHE42 Coriolis transmitter (intrinsically safe connections)

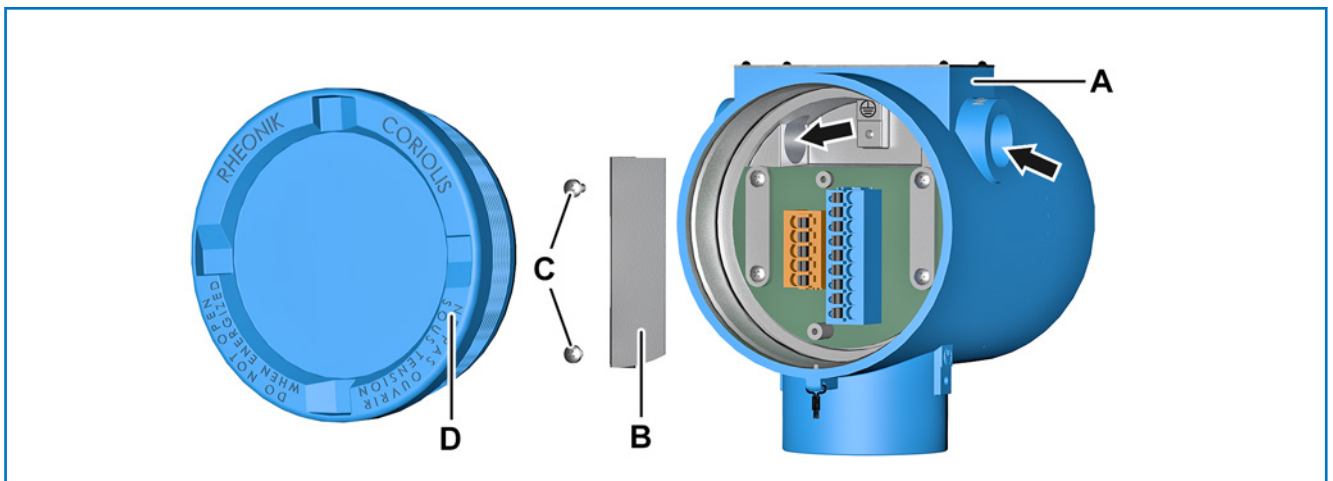

Fig. 9: Opening the RHE42 Coriolis transmitter

- A RHE42 Coriolis transmitter
- B Cover plate (only for intrinsically safe inputs and outputs)
- C Screws (only for intrinsically safe inputs and outputs)
- D Cover

- 1.** ➤ Remove the cover (D) from the RHE42 Coriolis transmitter (A), for example using a strap spanner.
- 2.** ➤ Undo the screws (C) and remove the cover plate (B) (only for intrinsically safe inputs and outputs).
- 3.** ➤ Screw the appropriate cable glands (NPT ½ inch with Ex e or Ex d approval if the device is being installed in an Ex zone / Div.) into the openings (arrows) of the RHE42 Coriolis transmitter (A) (the cable gland is not included in delivery).
- 4.** ➤ Guide the cable through the cable glands and into the RHE42 Coriolis transmitter (A).

- 5.** → Connect the wires to on the RHE42 Coriolis transmitter (A):
- → [Figure 7: Wiring diagram for the RHE42-R* \(not intrinsically safe\)](#)
 - → [Figure 8: Wiring diagram for the RHE42-R* \(intrinsically safe\)](#)



The connection terminals are equipped with push-in terminals. Wires with wire ferrules can be directly inserted. To connect a wire without a wire ferrule or to release a wire, ensure the latch is pressed in as you insert/remove the wire.



Detailed information on how to connect individual cables is provided in the following chapters:

- → [Chapter 7.3.1 'Connecting the power supply' on page 37](#)
- → [Chapter 7.4.1 'Connecting non-intrinsically safe analogue outputs' on page 41](#)
- → [Chapter 7.5.1 'Connecting intrinsically safe analogue outputs' on page 45](#)
- → [Chapter 7.4.2 'Connecting non-intrinsically safe digital outputs' on page 42](#)
- → [Chapter 7.5.2 'Connecting intrinsically safe digital outputs' on page 46](#)
- → [Chapter 7.4.3 'Connecting non-intrinsically safe digital inputs' on page 43](#)
- → [Chapter 7.5.3 'Connecting intrinsically safe digital inputs' on page 46](#)
- → [Chapter 7.3.2 'Connecting the RS485 interface' on page 37](#)
- → [Chapter 7.4.4 'Connecting a non-intrinsically safe HART interface' on page 44](#)
- → [Chapter 7.3.3 'Connecting the Modbus TCP interface' on page 39](#)
- → [Chapter 7.3.4 'Connecting the Foundation Fieldbus / Profibus interface' on page 40](#)



National and local regulations in force may stipulate additional grounding requirements. Ensure that all grounding methods meet these requirements.

- 6.** → Route the wires in the housing of the RHE42 Coriolis transmitter (A) such that they cannot become damaged by being trapped or from tensile forces.
- 7.** → Tighten the cable gland (NPT ½ inch with Ex e or Ex d approval if the device is being installed in an Ex zone / Div.) (the cable gland is not included in delivery).
- 8.** → Screw the cover plate (B) tight using the screws (C) (only for intrinsically safe inputs and outputs).
- 9.** → Fit the cover (D) onto the RHE42 Coriolis transmitter (A), for example using a strap spanner.

7.3 Wiring diagrams for the power supply, RS485 and Modbus TCP

7.3.1 Connecting the power supply

The RHE42 Coriolis transmitter requires a regulated DC power supply of 12 to 24 V \pm 10%.

The power consumption is 2 to max. 4 W.

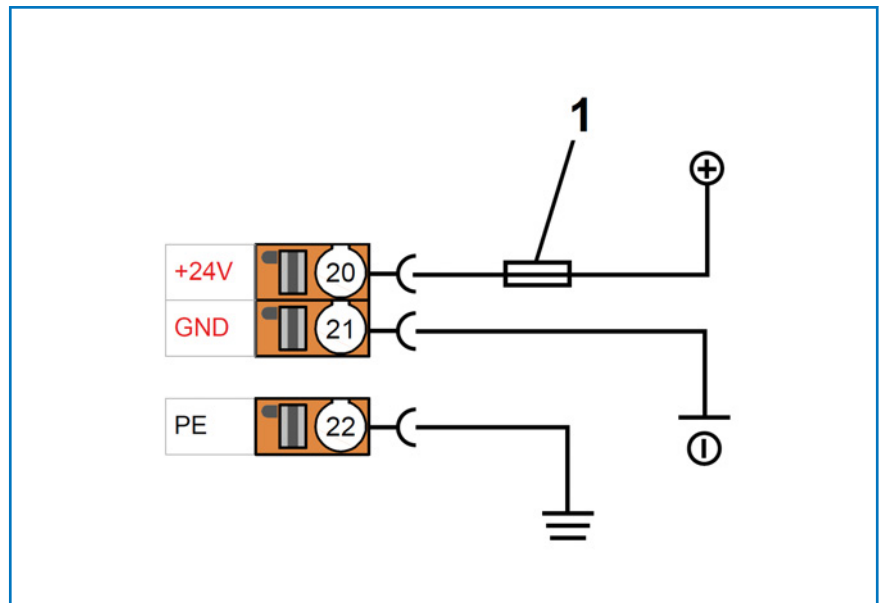

Fig. 10: Power supply connection

- 1 Fuse (suitable for the cable being used, max. 10 A)
- 20 +24 V connection
- 21 Ground connection
- 22 Connection for protective conductor

- 1.** Connect the positive DC power connection of the power supply to the +24 V connection (20) and protect it with a fuse (1).
- 2.** Connect the negative DC power connection of the power supply to the ground connection (21).
- 3.** Connect a protective conductor to a corresponding junction point and to the connection for the protective conductor (22).

7.3.2 Connecting the RS485 interface

The RS485 interface is used for digital communications, for remote control purposes, and to exchange data. It uses the Modbus protocol to establish a permanent connection to a monitoring control system.

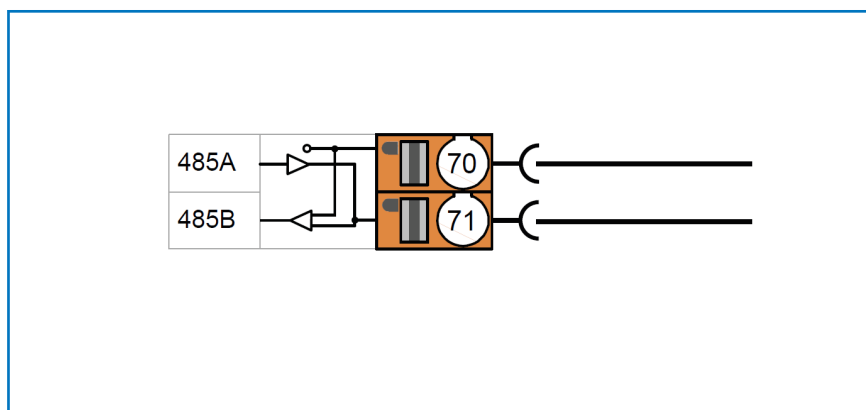

Fig. 11: RS485 interface connection

70 RS 485 (+) connection

71 RS 485 (-) connection

- 1.** ➤ Connect the Tx+ / Rx+ connection to the RS 485 (+) connection (70).
- 2.** ➤ Connect the Tx- / Rx- connection to the RS 485 (-) connection (71).

Switching the termination switch

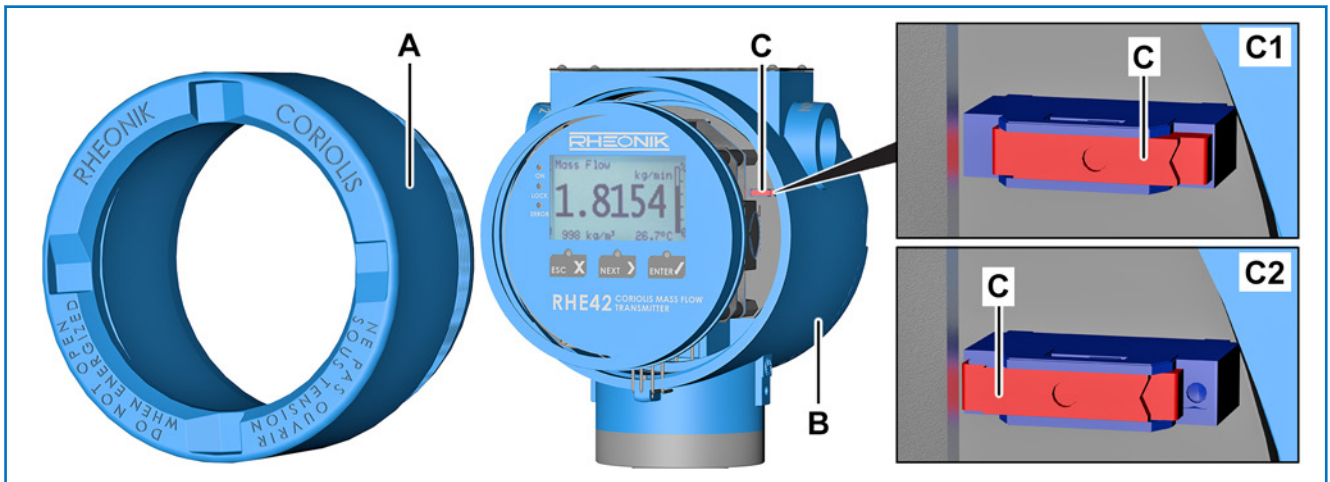

Fig. 12: Termination switch

- A Cover
- B RHE42 Coriolis transmitter
- C Termination switch
- C1 ON position
- C2 OFF position

1. ➔



The RHE42 Coriolis transmitter has a $120\ \Omega$ terminating resistor with termination switch. The termination switch is located on a circuit board inside the RHE42 Coriolis transmitter. Ex works the termination switch is set to ON. If several RHE42 Coriolis transmitters are connected to the same RS485 cable, the termination switches must be set to OFF on all RHE42 Coriolis transmitters, except for the termination switch of the RHE42 Coriolis transmitter at the end of the RS485 cable.

Remove the cover (A) from the RHE42 Coriolis transmitter (B), for example using a strap spanner.

2. ➔

Slide the termination switch (C) to the required position:

- The ON position (C1) by sliding it to the right.
- The OFF position (C2) by sliding it to the left.

3. ➔

Fit the cover (A) onto the RHE42 Coriolis transmitter (B), for example using a strap spanner.

7.3.3 Connecting the Modbus TCP interface

This process describes how to connect to a MODBUS TCP interface with a CAT5 cable in accordance with TIA-568B by way of example.

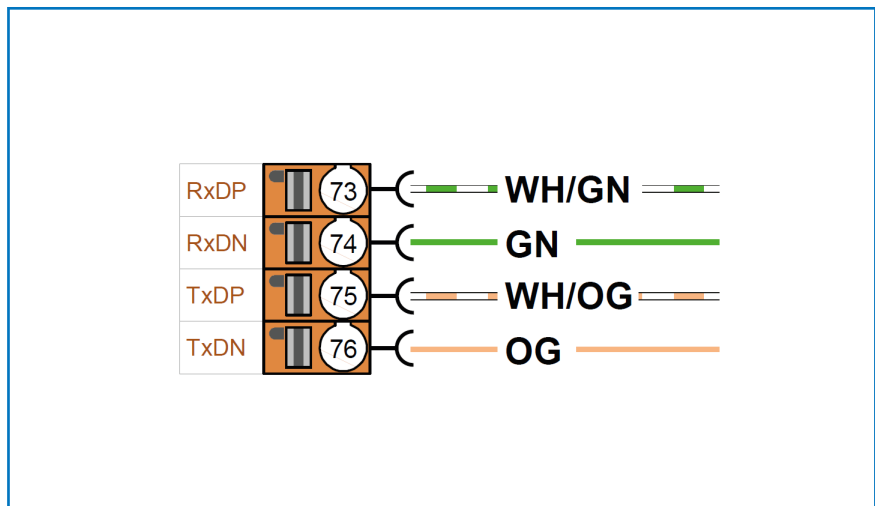

Fig. 13: Connection of a MODBUS TCP interface with a CAT5 cable in accordance with TIA-568B

- 73 Connection for Modbus TCP RxD+
- 74 Connection for Modbus TCP RxD-
- 75 Connection for Modbus TCP TxD+
- 76 Connection for Modbus TCP TxD-
- GN Green Modbus cable
- OG Orange Modbus cable
- WH/GN White/green Modbus cable
- WH/OG White/orange Modbus cable

- 1.** Connect the white/green Modbus cable (WH/GN) to the connection for Modbus TCP RxD+ (73).
- 2.** Connect the green Modbus cable (GN) to the connection for Modbus TCP RxD- (74).
- 3.** Connect the white/orange Modbus cable (WH/OG) to the connection for Modbus TCP TxD+ (75).
- 4.** Connect the orange Modbus cable (OG) to the connection for Modbus TCP TxD- (76).

7.3.4 Connecting the Foundation Fieldbus / Profibus interface

The Foundation Fieldbus FFH1 (FISCO) and the Profibus PA (FISCO) are only permitted to be used in conjunction with certified barriers/supply isolators.



In FISCO bus systems, the barrier/supply isolator comes built in.

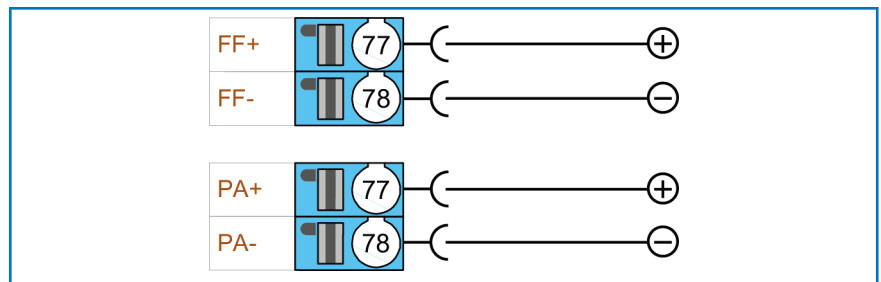

Fig. 14: Foundation Fieldbus / Profibus interface connection

- 77 Foundation Fieldbus FFH1 (FISCO) (+) connection (version FF, F2)
- 78 Foundation Fieldbus FFH1 (FISCO) (-) connection (version FF, F2)
- 77 Profibus PA (FISCO) (+) connection (version PA, P2)
- 78 Profibus PA (FISCO) (-) connection (version PA, P2)

1. Connect the positive output of the FISCO bus system to the Foundation Fieldbus FFH1 / Profibus PA (FISCO) (+) connection (77).
2. Connect the negative output of the FISCO bus system to the Foundation Fieldbus FFH1 / Profibus PA (FISCO) (-) connection (78).

7.4 Wiring diagrams for non-intrinsically safe inputs and outputs

7.4.1 Connecting non-intrinsically safe analogue outputs

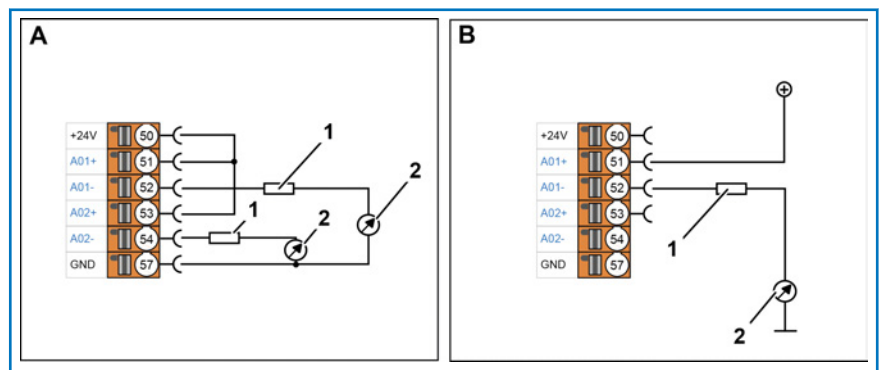

Fig. 15: Connection of analogue outputs (not intrinsically safe)

- A Operation as active output
- B Operation as passive output
- 1 Protective resistor
- 2 Local display/PLC/monitoring control system
- 50 Connection for +24 V (output for active wiring of the analogue outputs)
- 51 Connection for passive analogue output 1 (+)
- 52 Connection for passive analogue output 1 (-)
- 53 Connection for passive analogue output 2 (+)
- 54 Connection for passive analogue output 2 (-)
- 57 Ground connection (analogue outputs)

Operation as active output (A) (described using both analogue outputs by way of example)

1. Connect the connection for passive analogue output 1 (+) (51) and the connection for passive analogue output 2 (+) (53) to the +24 V connection (50).

2. → Connect the analogue current inputs (4 – 20 mA) of the local display/PLC/monitoring control system (2) to the connection for passive analogue output 1 (-) (52) and the connection for passive analogue output 2 (-) (54).



If you are using a 24 V DC power supply, we **recommend** inserting a 510 Ω protective resistor upstream of the local display/PLC/monitoring control system.

3. → Connect the ground of your local display/PLC/monitoring control system (2) to the ground connection (57).

Operation as passive output (B) (described using the passive analogue output 1 by way of example)

1. → Connect a suitable power supply (max. 24 V DC) to the connection for passive analogue output 1 (+) (51).

2. → Connect the digital input (24 V level) of the local display/PLC/monitoring control system (2) to the connection for passive analogue output 1 (-) (52).



If you are using a 24 V DC power supply, we **recommend** inserting a 510 Ω protective resistor upstream of the local display/PLC/monitoring control system.

3. → Connect the ground of your local display/PLC/monitoring control system (2) to the ground connection of the external power source.

7.4.2 Connecting non-intrinsically safe digital outputs

The following section describes the various connection variants that apply for digital outputs, using the active digital output 1 by way of example. The active digital output 2 can be connected in the same way.

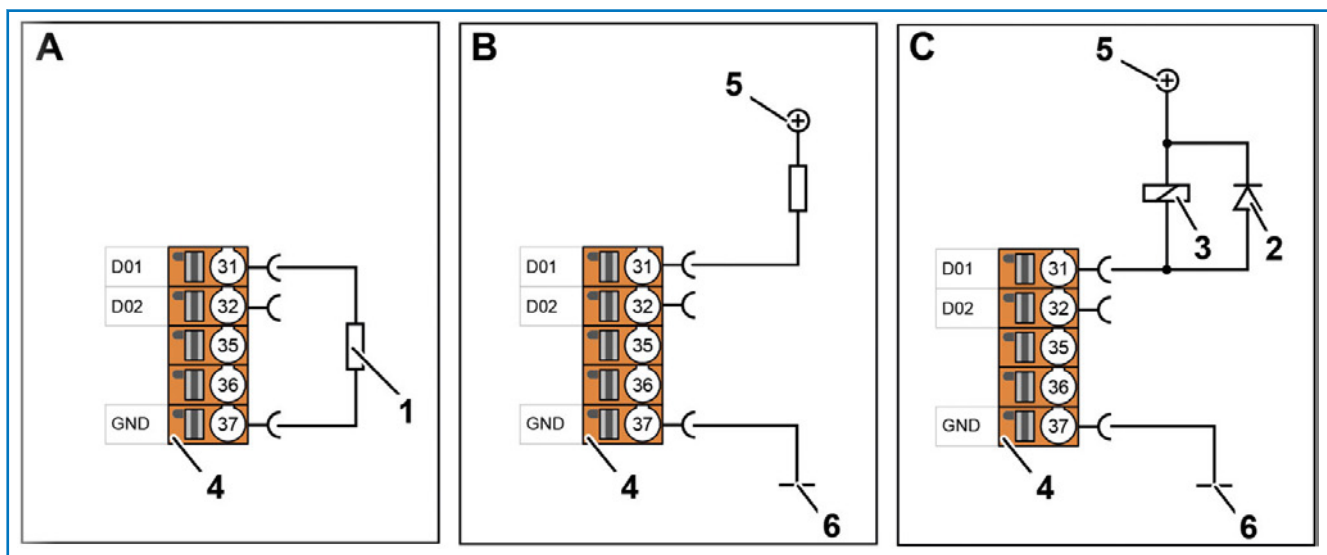

Fig. 16: Connection of digital outputs (not intrinsically safe)

- | | | | |
|---|---|----|--|
| A | Load to ground (I_{max} 20 mA) | 3 | Relay |
| B | Load to +24 V (I_{max} 100 mA) | 4 | Connection terminal |
| C | Relay to +24 V (I_{max} 100 mA) | 5 | +24 V power supply |
| 1 | Load | 6 | Mass |
| 2 | Free-wheeling diode for relay (essential) | 31 | Connection for active digital output 1 |

32 Connection for active digital output 2
 37 Ground connection (digital inputs and outputs)



In the case of load or relay to +24 V, the low state of the output is the active state.

Load to ground (I_{max} 20 mA) (A)

1. ➤ Connect the input of the connected load (1) to the connection for active digital output 1 (31).
2. ➤ Connect the output of the load (1) to the ground connection (37).

Load to +24 V (I_{max} 100 mA) (B)

1. ➤ Connect the negative connection of the load (1) to the connection for active digital output 1 (31).
2. ➤ Connect the +24 V power supply (5) to the positive connection of the load (1).
3. ➤ Connect the ground (6) of the external power source to the ground connection (37) (only if you are using an external +24 V power supply (5)).



If the power supply is being provided via the RHE42 Coriolis transmitter, do not connect the ground connection.

Relay to +24 V (I_{max} 100 mA) (C)

1. ➤ Connect the negative connection of the relay (3) to the connection for active digital output 1 (31).
2. ➤ Connect the +24 V power supply (5) to the positive connection of the relay (3).
3. ➤ Connect the load circuit of the relay (3) to the load that needs to be switched.
4. ➤ Connect the ground (6) of the external power source to the ground connection (37) (only if you are using an external +24 V power supply (5)).



If the power supply is being provided via the RHE42 Coriolis transmitter, do not connect the ground connection.

7.4.3 Connecting non-intrinsically safe digital inputs



The digital input has an input resistor of 24 kΩ and draws approx. 1 mA during operation if it is connected to a 24 V DC supply. The input voltage must not exceed a max. of 30 V DC.

The following section describes how to connect digital input 1. Digital input 2 can be connected in the same way.

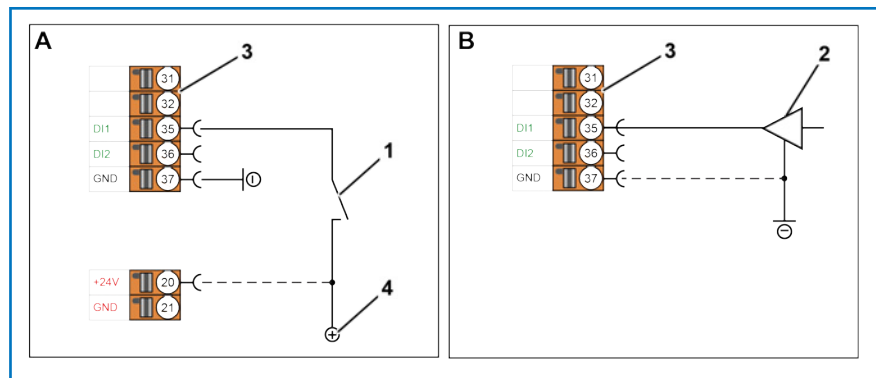

Fig. 17: Connection of digital inputs (not intrinsically safe)

A Connection for switch

B Connection for driver

1 Switch

2 Driver

3 Connection terminal

4 +24 V power supply

20 +24 V connection

35 Connection for passive digital input 1 (version B1, EB, EA, S1, 1H)

36 Connection for passive digital input 2 (version B1, EB)

37 Ground connection (digital inputs and outputs)

Connection for switch (A)

1. ➔ Connect a suitable +24 V power supply (4) to the connection for passive digital input 1 (35).
2. ➔ Connect the ground of the external +24 V power supply (4) to the ground connection (37) (only if you are using an external +24 V power supply (4)).



If the power supply is being provided via the RHE42 Coriolis transmitter, do not connect the ground connection.

Connection for driver (B)

1. ➔ Connect the output of your driver (2) to the connection for passive digital input 1 (35).
2. ➔ Connect the ground for the driver (2) to the connection for ground (37) when the ground of the driver (2) and the ground of RHE42 Coriolis transmitter are not connected via the power supply.



If the power supply is being provided via the RHE42 Coriolis transmitter, do not connect the ground connection.

7.4.4 Connecting a non-intrinsically safe HART interface



A 250 Ω load resistor that is switched in parallel is recommended for analogue outputs that use HART communication.

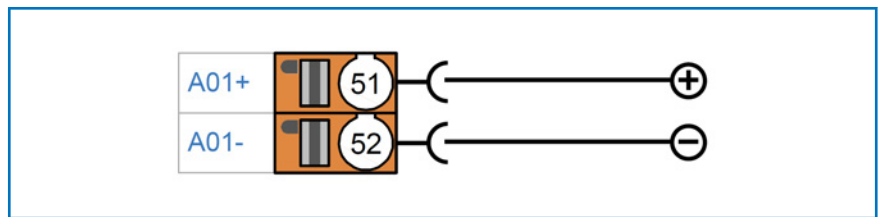

Fig. 18: HART interface connection

- 51 Connection for passive analogue output 1 (+) (for HART communication)
- 52 Connection for passive analogue output 1 (-) (for HART communication)

1. Connect the positive connection of the HART modem to the connection for passive analogue output 1 (+) (51).
2. Connect the negative connection of the HART modem to the connection for passive analogue output 1 (-) (52).



The HART interface can also be configured as an active output. For details of the connection for this, please see: → Chapter 7.4.1 'Connecting non-intrinsically safe analogue outputs' on page 41.

7.5 Wiring diagrams for intrinsically safe inputs and outputs

7.5.1 Connecting intrinsically safe analogue outputs

The intrinsically safe analogue outputs must only be used in conjunction with certified barriers/supply isolators.

The following section describes how to connect the intrinsically safe analogue output 1. The intrinsically safe analogue output 2 can be connected in the same way.

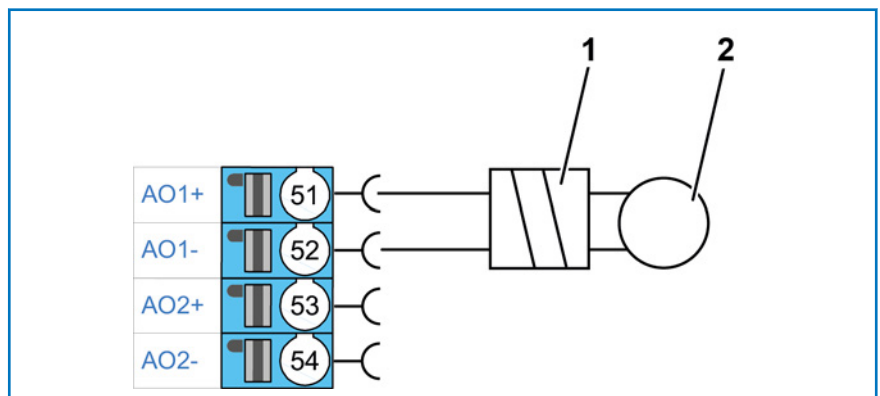

Fig. 19: Connection of analogue outputs (intrinsically safe)

- 1 Certified barrier/supply isolator
- 2 Local display/PLC/monitoring control system
- 51 Connection for analogue output 1 (+)
- 52 Connection for analogue output 1 (-)
- 53 Connection for analogue output 2 (+)
- 54 Connection for analogue output 2 (-)

1. Connect a certified barrier/supply isolator (1) to the connection for analogue output 1 (+) (51) and the connection for analogue output 1 (-) (52).

- 2.** → Connect the certified barrier/supply isolator (1) to the local display/PLC/monitoring control system (2) in accordance with the corresponding data sheet.

7.5.2 Connecting intrinsically safe digital outputs

The intrinsically safe digital outputs must only be used in conjunction with certified barriers/supply isolators.

The following section describes how to connect the intrinsically safe digital output 1. The intrinsically safe digital output 2 can be connected in the same way.

i *Operation is possible with a NAMUR supply isolator.*

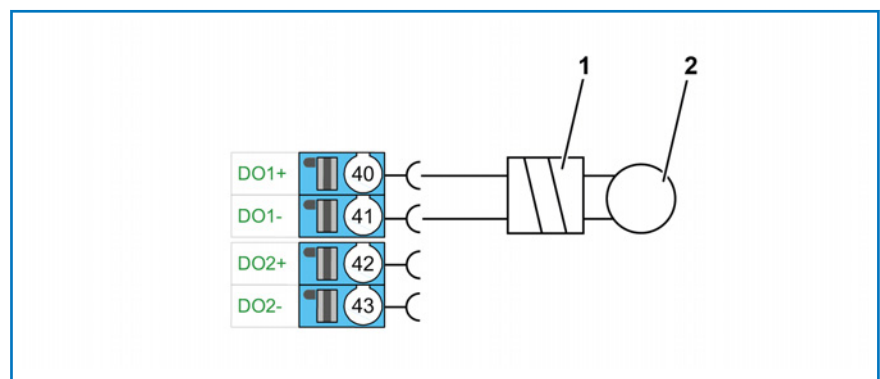

Fig. 20: Connection of digital outputs (intrinsically safe)

- 1 Certified barrier/supply isolator
- 2 Local display/PLC/monitoring control system
- 40 Connection for digital output 1 (+)
- 41 Connection for digital output 1 (-)
- 42 Connection for digital output 2 (+)
- 43 Connection for digital output 2 (-)

- 1.** → Connect a certified barrier/supply isolator (1) to the connection for digital output 1 (+) (40) and the connection for digital output 1 (-) (41).
- 2.** → Connect the certified barrier/supply isolator (1) to the local display/PLC/monitoring control system (2) in accordance with the corresponding data sheet.

7.5.3 Connecting intrinsically safe digital inputs

The intrinsically safe digital inputs must only be used in conjunction with certified barriers/supply isolators.

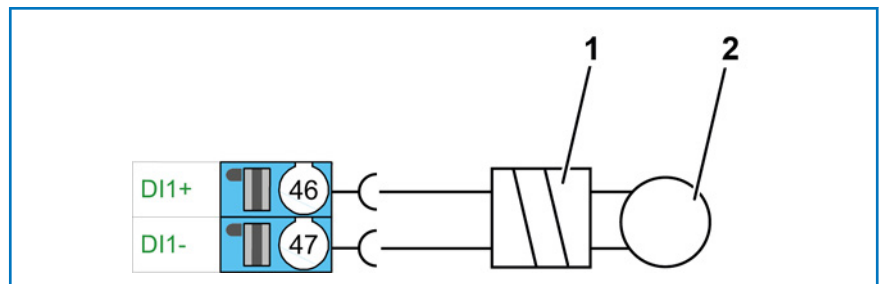

Fig. 21: Connection of digital inputs (intrinsically safe)

- 1 Certified barrier/supply isolator
- 2 Local display/PLC/monitoring control system
- 46 Connection for digital input (+)
- 47 Connection for digital input (-)

1. ➤ Connect a certified barrier/supply isolator (1) to the connection for digital input 1 (+) (46) and the connection for digital input 1 (-) (47).
2. ➤ Connect the certified barrier/supply isolator (1) to the local display/PLC/monitoring control system (2) in accordance with the corresponding data sheet.

7.5.4 Connecting an intrinsically safe HART interface



A 250 Ω load resistor that is switched in parallel is recommended for analogue outputs that use HART communication.

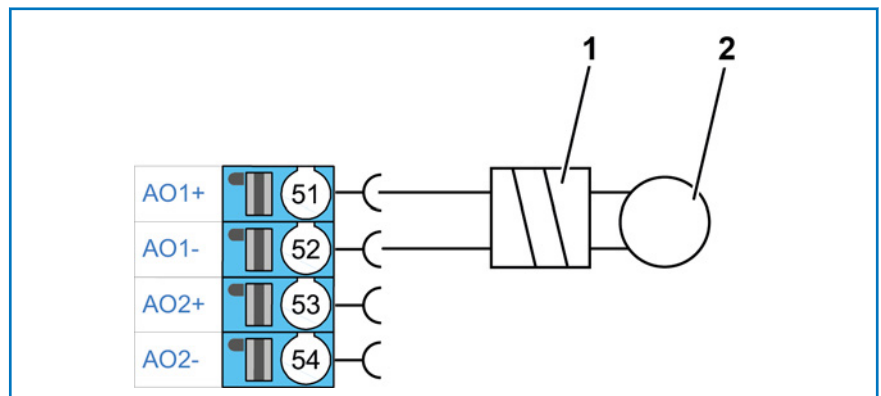

Fig. 22: HART interface connection

- 1 HART transparent supply isolator
- 2 HART modem (plus supply)
- 51 Connection for analogue output 1 (+)
- 52 Connection for analogue output 1 (-)



1. ➤ Connect the HART transparent supply isolator (1) to the connection for analogue output 1 (+) (51) and to the connection for analogue output 1 (-) (52).
2. ➤ Connect the HART transparent supply isolator (1) with the HART modem (2). Observe the instructions supplied in delivery.

8 Start-up

There are 5 ways to call up the data of, and configure, the RHE42 Coriolis transmitter:

- Use the three keys on the front of the RHE42 Coriolis transmitter. The data you enter will be shown on the colour LCD display.
- Use the RHECom PC software via the RS 485 serial interface or Ethernet; see: RHEComPro Suite User Manual.
- Use Modbus commands via the RS 485 serial interface or Ethernet; see: RHE 40 desktop reference and RHE16/20/40 Modbus Map.
- Use the HART interface AO1/AO2; see: RHE 40 HART Manual.
- Use the Foundation Fieldbus/Profibus interface (restricted configuration).

8.1 Function of the keys on the RHE42 Coriolis transmitter

There are three keys for operating the RHE42 Coriolis transmitter, which are identified with "ESC" , "NEXT"  and "ENTER" . The functions that these keys control depend on what is currently being displayed.

This chapter provides a brief introduction into how to operate the RHE42 Coriolis transmitter using the user interface. Further information is provided in the RHE 40 desktop reference. The RHE 40 desktop reference is available to download from the Rheonik Messtechnik GmbH website: <http://rheonik.com>.

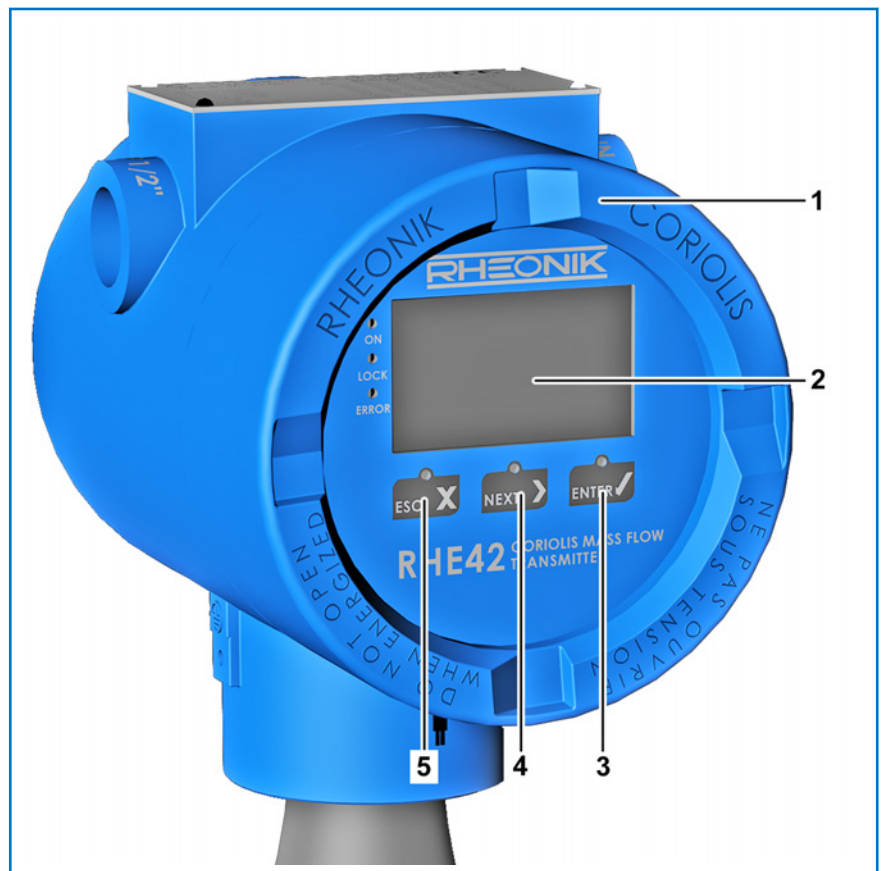



















Fig. 23: Function keys

- 1 RHE42 Coriolis transmitter
- 2 Display

- 3  key
- 4  key
- 5  key

Task	Key	Note
Select menu		Navigates to the menu one level higher.
		Selects the next menu item.
		Moves down one level in the menu or opens an input window.

Tab. 11: Menu selection

Task	Key	Note
Undo		Exits the input window and returns to the previous menu without saving your changes.
Enter numbers		Increments the numerical value at the cursor position by one. Upon reaching 9 , the numerical value jumps back to 0 (decimal numbers). Upon reaching F , the numerical value jumps back to 0 (hexadecimal numbers) (used for the service password).
Change prefix		Changes + to - and vice versa. If you enter a number with a prefix, the cursor will start at the first character to the right of the prefix. To change the prefix, press the  key until the entire display starts flashing. You can now change the prefix by pressing the  key.
Change position of decimal separator		Moves the decimal separator and the cursor position one digit to the right.
Repeat entry		If you press the  key on the right in an input window, the number will flash. If you press the  key whilst the entry is flashing, the cursor will return to the start of the input window.
Continue after entering data		Moves the cursor in an input window one character to the right.
End entry of numbers		If the cursor is at the far right of the input window and you then press the  key, the entire input window will flash. Pressing the  key again will apply the modified number and the display will return to the previous menu.

Tab. 12: Entering numbers



If you enter a numerical value that is outside the permissible range for the parameters, the input window will reverse the colours (light to dark instead of dark to light). If you want to change this numerical value, press the  key after the final digit. The cursor will jump back to the left-hand position so that you can edit your entry again.

Task	Key	Note
Status information – bit status displays	ENTER ✓	Increase the index of the individual bits in the status values. Repeatedly pressing the ENTER key in the “Error Status”, “Soft Error Status” or “Warnings” displays enables each individual bit value and its status description to be displayed and read out.

Tab. 13: Status information – bit status displays

8.2 Operation

Entering the password (PWD)

You will need to enter a password before being able to configure and execute certain features of the RHE42 Coriolis transmitter. The password protects the configuration and prevents it being changed accidentally.

There are two access levels with different passwords:

- **User Login**
- **Service Login**

The **User Login** enables the user to access the features that relate to the day-to-day use of the RHE42 Coriolis transmitter, e.g. calibrating the zero point and resetting the totaliser.

The **Service Login** enables the user to configure the RHE42 Coriolis transmitter and adjust settings (e.g. relating to I/O).

The display will prompt the user to enter the password.





The user password can be changed in the **Service Login** menu.

User password	1111
Service password	5678

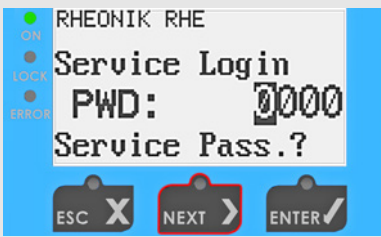
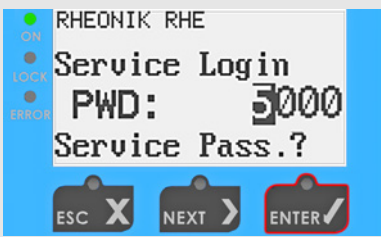
Tab. 14: Default password settings

Display shows	Steps to take	Note
	Press the NEXT key 5 times.	The number of actions performed depends on the character being selected.
	Press the ENTER key once.	The entry is confirmed.

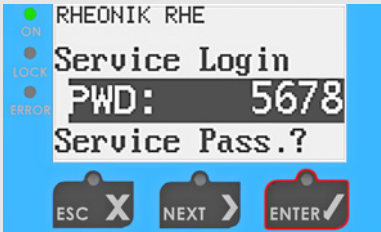
Display shows	Steps to take	Note
	Press the NEXT > key 6 times.	
	Press the ENTER ✓ key once.	
	Press the NEXT > key 7 times.	
	Press the ENTER ✓ key once.	
	Press the NEXT > key 8 times.	
	Press the ENTER ✓ key once.	The entry of the last character is confirmed.

Display shows	Steps to take	Note
	Press the  key once.	The entry of the entire code is confirmed.

Tab. 15: Entering the password using the numerical code 5678 by way of example

8.3 Initial start-up

1. ▶ Switch on the power supply.
 - ▶ The display backlight lights up. Once the device has run through a start-up sequence, the display for the flow measurement appears.



If an error has occurred, the backlight will light up red.

For detailed information on the error messages see: [▶ Chapter 11 'Displaying errors' on page 85.](#)

2. ▶ Rinse the RHM Coriolis sensor with process fluid.



Ensure that there are no air bubbles (if using a liquid process medium) or residual fluid (if using a gaseous process medium).

3. ▶ Wait for the temperature of the RHM Coriolis sensor to stabilise.



The zero point should be calibrated under process conditions (temperature and pressure). If this is not done, minor measurement errors could occur.

4. ▶ Calibrate the zero point; see: [▶ Chapter 8.3.1 'Calibrating the zero point' on page 54.](#)

5. ▶ **Optional**

Read out the IP address to connect the RHE42 Coriolis transmitter with your own network using Modbus TCP; see: [▶ Chapter 8.3.3 'Reading out the IP address' on page 58.](#)



It is only possible to connect to your own network using Modbus TCP if you are using the configuration EB or EA.

6. → Optional

Set up the RS485 interface (if you are using these features); see:
→ [Chapter 8.3.4 'Setting up the RS485 interface' on page 59.](#)

Abbreviations on the display

- Tot (totaliser)
- LO-HI / L-H (transition from 0 to 24 V)
- HI-LO / H-L (transition from 24 to 0 V)



8.3.1 Calibrating the zero point



Calibrating the zero point ensures that the measurements are accurate within the permissible tolerance.

	NOTICE
	<p>Damage to property due to measured values being falsified by an incorrectly calibrated zero point!</p> <p>The zero point may only be calibrated if nothing is flowing in the RHM Coriolis sensor.</p> <ul style="list-style-type: none">– Close all valves upstream and downstream of the RHM Coriolis sensor.– Check that nothing is flowing in the RHM Coriolis sensor.

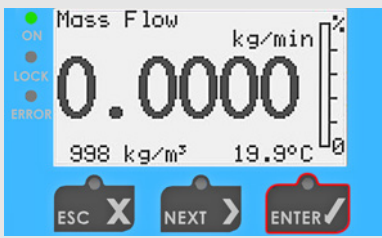
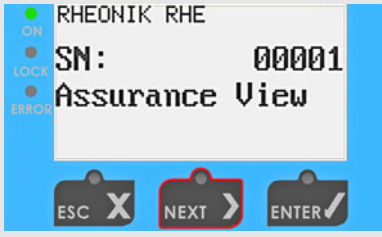
- 1. →** Before calibrating the zero point, close all valves upstream and downstream of the RHM Coriolis sensor.

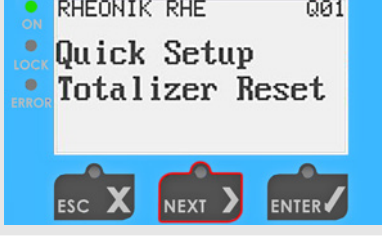
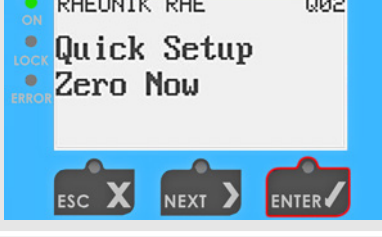
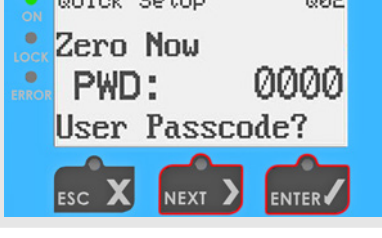
2. → Calibrate the zero point.

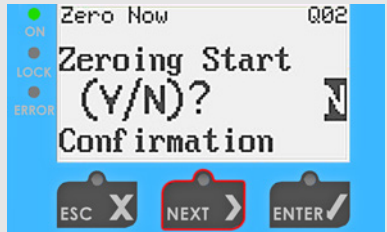
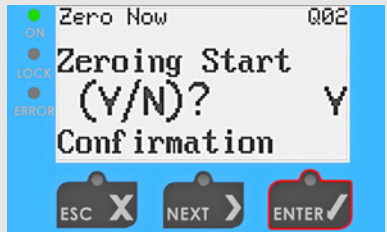
Display shows	Steps to take	Note
	Press the ENTER key once.	The valves upstream and downstream of the RHM Coriolis sensor must have been closed.
	Press the NEXT key 2 times.	
	Press the ENTER key once.	
	Press the NEXT key once.	
	Press the ENTER key once.	
	Enter the user password using the NEXT and ENTER keys.	→ <i>'Entering the password (PWD)' on page 51</i>

Display shows	Steps to take	Note
	Press the NEXT key once.	Select "Y" to confirm the calibrated zero point.
	Press the ENTER key once.	The zero point will be calibrated. Once the process is complete, the display will switch to the "Zero Now" menu.
	Press the ESC key 2 times.	The display returns to the default view.

Tab. 16: Calibrating the zero point



- After calibrating the zero point, open all valves upstream and downstream of the RHM Coriolis sensor.

8.3.2 Changing the flow direction

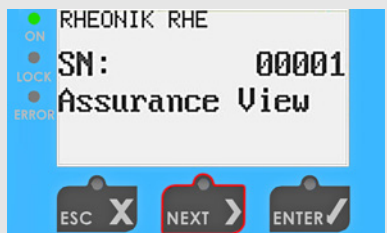
RHE42 Coriolis transmitters are bidirectional and can be operated in your desired flow direction. In certain circumstances, the RHE42 Coriolis transmitter may display negative values following installation as a result of the flow direction. If this happens, you can reverse how the flow direction is displayed in the RHE42 Coriolis transmitter.

Display shows	Steps to take	Note
	Press the ENTER key once.	
	Press the NEXT key 2 times.	

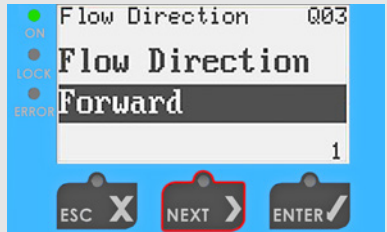
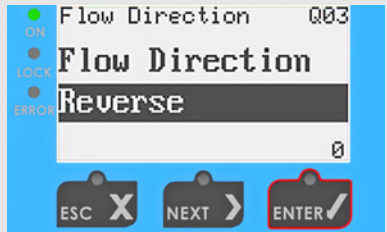
Display shows	Steps to take	Note
	<p>Press the  key once.</p>	
	<p>Press the  key 2 times.</p>	
	<p>Press the  key once.</p>	
	<p>Enter the user password using the  and  keys.</p>	<p>→ <i>'Entering the password (PWD)' on page 51</i></p>
	<p>Press the  key 2 times.</p>	
	<p>Press the  key once.</p>	

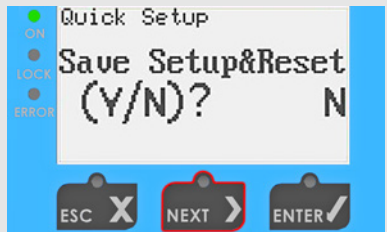
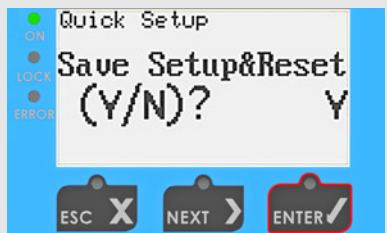

Display shows	Steps to take	Note
	Press the NEXT key once.	
	Press the ENTER key once.	
	Press the ESC key once.	
	Press the NEXT key once.	Select "Y" to save the changes.
	Press the ENTER key once.	The display returns to the default view.

Tab. 17: Changing the flow direction

8.3.3 Reading out the IP address

This information is only required for the use of the Modbus TCP interface.

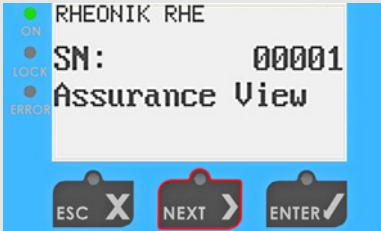
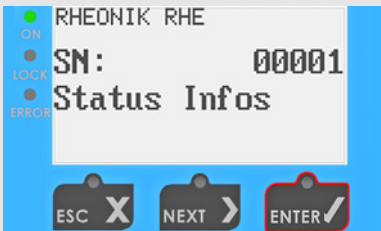
Once the RHE42 Coriolis transmitter has been connected, it is assigned an IP address, which is required in order to connect the RHE42 Coriolis transmitter with your own network via the Modbus TCP interface.

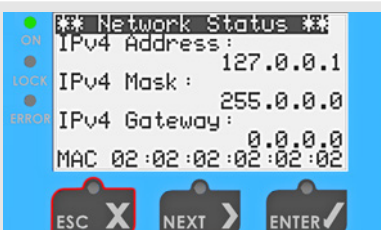

Display shows	Steps to take	Note
	Press the ENTER key once.	
	Press the NEXT key once.	
	Press the ENTER key once.	
	Press the NEXT key 3 times.	
	Press the ESC key 2 times to return to the default view.	<p>The IP addresses are shown on the display.</p> <p>To connect the RHE42 Coriolis transmitter with your own network, you need the address listed under "IPv4 Address:".</p> <p>The address shown here is merely an example. The actual correct address will be shown on the display.</p>

Tab. 18: Reading out the IP address

8.3.4 Setting up the RS485 interface

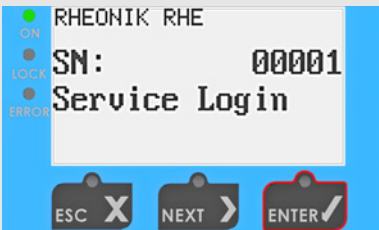
Once the RHE42 Coriolis transmitter has been connected, the RS485 interface must be set up before it can be used.

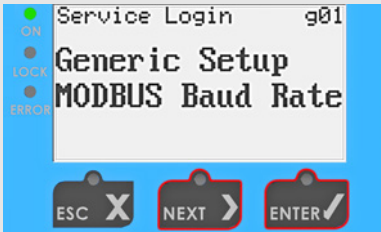

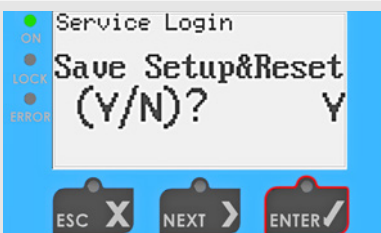
Display shows	Steps to take	Note
	Press the ENTER key once.	
	Press the NEXT key 7 times.	
	Press the ENTER key once.	
	Enter the service password 5678 using the NEXT and ENTER keys.	→ 'Entering the password (PWD)' on page 51
	Press the NEXT key 8 times.	
	Press the ENTER key once.	

Display shows	Steps to take	Note
	<p>Select the relevant menus one after the other by pressing the NEXT > key and confirm your entry by pressing the ENTER ✓ key.</p>	<p>The RS485 interface settings need to be configured in all four of the following menus:</p> <ul style="list-style-type: none"> ■ MODBUS Baud Rate ■ MODBUS Parity ■ MODBUS Stop Bits ■ MODBUS Slave Add <p>The following three setting options are available for the MODBUS Parity menu:</p> <ul style="list-style-type: none"> ■ 0 (None) ■ 1 (Odd) ■ 2 (Even)
	<p>Press the ESC X key once.</p>	
	<p>Press the NEXT > key once.</p>	<p>Select "Y" to save the changes.</p>
	<p>Press the ENTER ✓ key once.</p>	<p>The display returns to the default view.</p>

Tab. 19: Setting up the RS485 interface

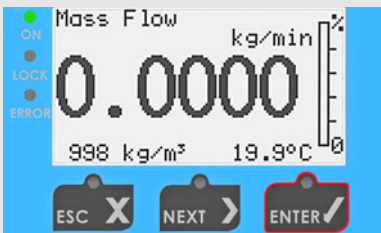
8.3.5 Setting the units of measurement

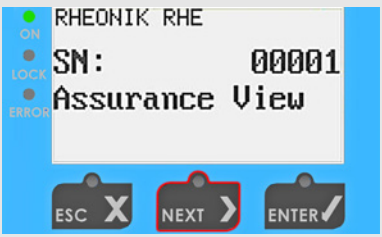
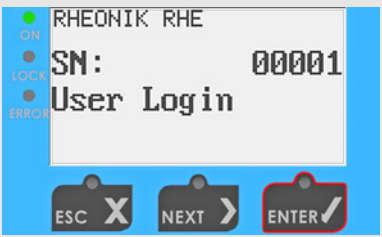
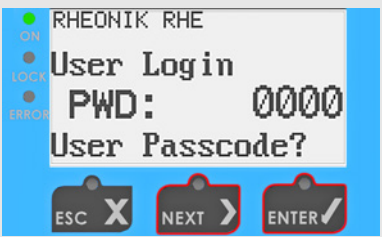
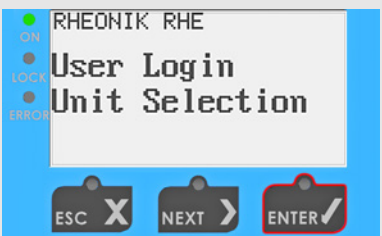
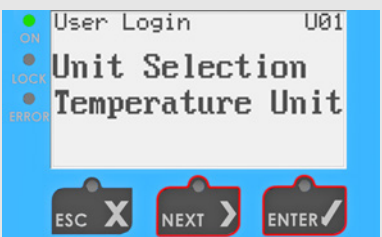

Display shows	Steps to take	Note
	<p>Press the ENTER ✓ key once.</p>	

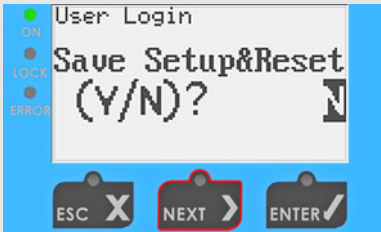
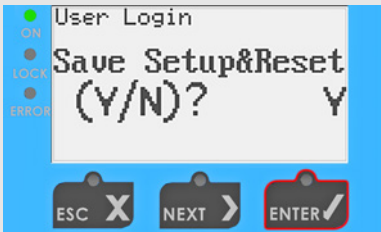
Display shows	Steps to take	Note
	<p>Press the NEXT > key 6 times.</p>	
	<p>Press the ENTER ✓ key once.</p>	
	<p>Enter the user password using the NEXT > and ENTER ✓ keys.</p>	<p>↪ <i>'Entering the password (PWD)' on page 51</i></p>
	<p>Press the ENTER ✓ key once.</p>	
	<p>Select the relevant menu for setting the measured values by pressing the NEXT > key and confirm your entry by pressing the ENTER ✓ key.</p> <p>Pressing the ENTER ✓ key takes you to the menu for setting the units of measurement. Confirm your selection by pressing the ENTER ✓ key.</p>	<p>Selection:</p> <ul style="list-style-type: none"> ■ Temperature Unit ■ Pressure Unit ■ Mass Unit ■ Mass Flow Unit ■ Density Unit ■ Volumetric Flow Unit ■ Volume Unit
	<p>Press the ESC X key 2 times.</p>	

Display shows	Steps to take	Note
	Press the NEXT key once.	Select "Y" to save the changes.
	Press the ENTER key once.	The display returns to the default view.

Tab. 20: Setting the units of measurement

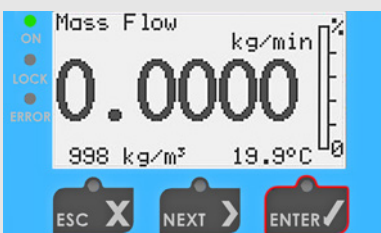
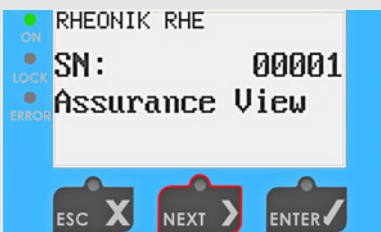
8.3.6 Configuring analogue outputs

Display shows	Steps to take	Note
	Press the ENTER key once.	
	Press the NEXT key 2 times.	
	Press the ENTER key once.	
	Press the NEXT key 3 times.	

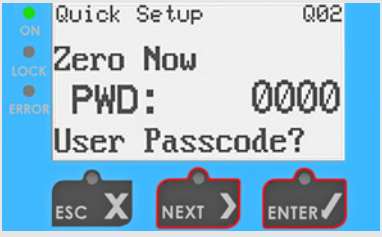
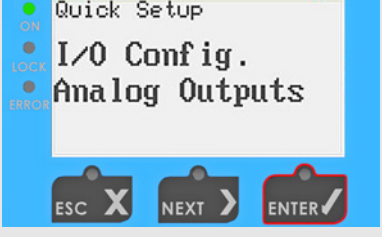
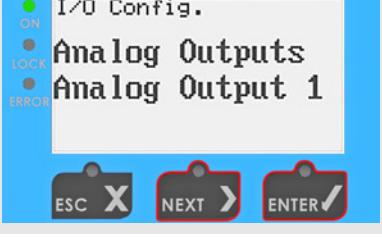
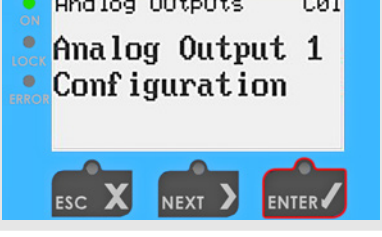
Display shows	Steps to take	Note
	Press the ENTER key once.	
	Enter the user password using the NEXT and ENTER keys.	→ <i>'Entering the password (PWD)' on page 51</i>
	Press the ENTER key once.	
	Select the analogue output you want to configure by pressing the NEXT key and confirm your entry by pressing the ENTER key.	Selection (depends on the device configuration): <ul style="list-style-type: none"> ■ Analogue Output 1 ■ Analogue Output 2
	Press the ENTER key once.	

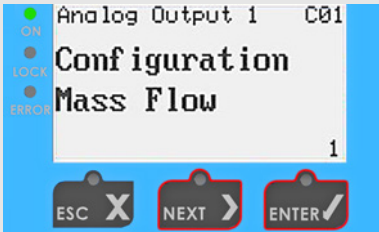
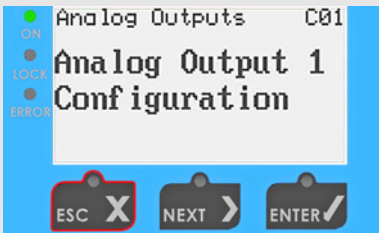
Display shows	Steps to take	Note
	<p>Select the measured value you need by pressing the NEXT key and confirm your entry by pressing the ENTER key.</p> <p>You can change the digits of the individual values by pressing the NEXT key. To confirm the selected digit, press the ENTER key.</p>	<p>Selection:</p> <ul style="list-style-type: none"> ■ Mass Flow ■ Volumetric Flow ■ Density ■ Tube Temp. (Temperatur des Messmediums) ■ Torsion Temp. ■ Drive Gain ■ Assurance Factor ■ Percent Main Sub ■ Off <p>Depending on which measured value you select, you can successively set the maximum value (Max), minimum value (Min), and how the analogue output should respond in certain situations (Fire State). The sequence and input options may vary depending on the measured value in question.</p>
	<p>Press the ESC X key 5 times.</p>	<p>The display returns to the default view.</p>

Tab. 21: Configuring an analogue output



Fire State (response by the analogue output)

The 'Fire State' menu sub-item enables you to set the following response by the analogue output:





- The 'on Range Ex' function issues a warning if the measuring range that was set beforehand is exceeded or undershot.
- The 'Error' function issues an error message if an error occurs.
- Both the 'on Range Ex' and the 'Error' function allow you to set the current value for the output signal.
- The 'PID Controller' function enables you to use the analogue output to directly control a valve or a pump for flow control purposes.

For detailed information on the 'PID Controller' function please see the supplementary documentation "RHE42/4X Addendum PID Control".

- If the measuring range is undershot or exceeded, the 'Clamp at Limits' function keeps the analogue output at the minimum or maximum value of the measuring range.

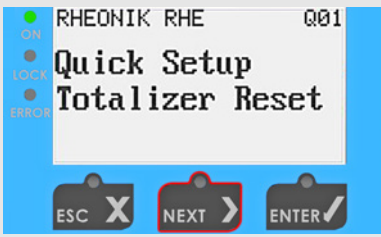
8.3.7 Configuring digital outputs

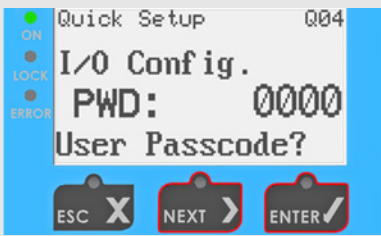
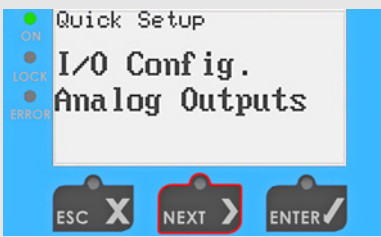
Display shows	Steps to take	Note
	Press the ENTER key once.	
	Press the NEXT key 2 times.	
	Press the ENTER key once.	

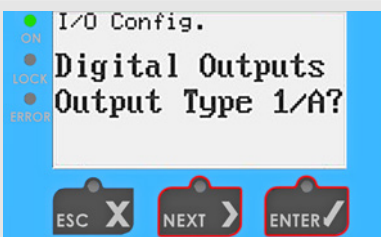
Display shows	Steps to take	Note
	<p>Press the NEXT > key 3 times.</p>	
	<p>Press the ENTER ✓ key once.</p>	
	<p>Enter the user password using the NEXT > and ENTER ✓ keys.</p>	<p>↪ <i>'Entering the password (PWD)' on page 51</i></p>
	<p>Press the NEXT > key once.</p>	
	<p>Press the ENTER ✓ key once.</p>	
	<p>Select the digital output you want to configure by pressing the NEXT > key and confirm your entry by pressing the ENTER ✓ key.</p>	<p>Selection (depends on the device configuration):</p> <ul style="list-style-type: none"> ■ Output Type 1/A ■ Output Type 2/B ■ Output Type 3 ■ Output Type 4

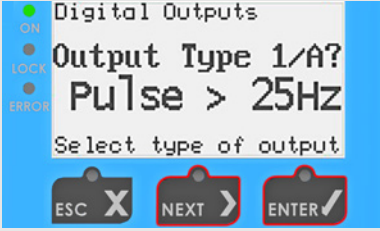
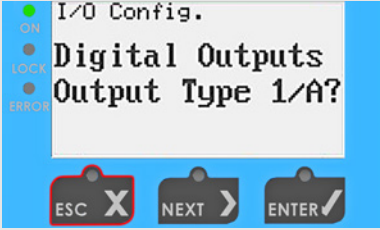
Display shows	Steps to take	Note
 <p>Digital Outputs ON LOCK ERROR Output Type 1/A? Pulse > 25Hz Select type of output ESC X NEXT > ENTER ✓</p>	<p>Select the measured value you need by pressing the NEXT key and confirm your entry by pressing the ENTER key.</p> <p>You can change the digits of the individual values by pressing the NEXT key. To confirm the selected digit, press the ENTER key.</p>	<p>Settings selection:</p> <ul style="list-style-type: none"> ■ Pulse > 25 Hz (“Output Type 1/A” and “Output Type 2/B”) <ul style="list-style-type: none"> - Mass - Volume ■ Pulse < 50 Hz (“Output Type 1/A” and “Output Type 2/B”) <ul style="list-style-type: none"> - Mass - Volume ■ Frequency (“Output Type 1/A” and “Output Type 2/B”) <ul style="list-style-type: none"> - Mass - Volume ■ Status/Configuration (“Output Type 1/A”, “Output Type 2/B”, “Output Type 3” and “Output Type 4”) <ul style="list-style-type: none"> - Mass Flow Limit - Volume Flow Limit - Density Limit - Tube Temp Limit - Tors. Temp Limit - Volume Rev Flow - Mass Fwd Tot Lmt - Volume Fwd Tot L - Error/Zero Low - Error/Zero High - Assurance Factor - Flow Direction (“Output Type 2/B” and “Output Type 3”) - Error (“Output Type 1/A” and “Output Type 4”) ■ Alarm Type (“Output Type 3” and “Output Type 4”) <ul style="list-style-type: none"> - Set HI/Reset LO - In Band LO-HI - Out Band LO-HI ■ Alarm Limit Low (“Output Type 3” and “Output Type 4”) ■ Alarm Limit High (“Output Type 3” and “Output Type 4”)
 <p>I/O Config. ON LOCK ERROR Digital Outputs Output Type 1/A? ESC X NEXT > ENTER ✓</p>	<p>Press the ESC X key 3 times.</p>	

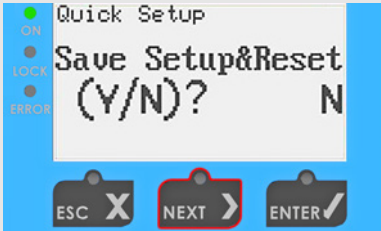
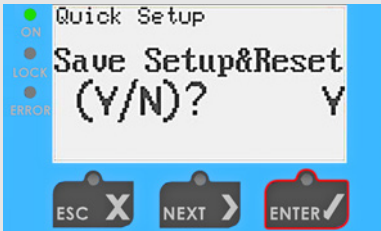
Display shows	Steps to take	Note
	Press the NEXT key once.	Select "Y" to save the changes.
	Press the ENTER key once.	The display returns to the default view.

Tab. 22: Configuring a digital output









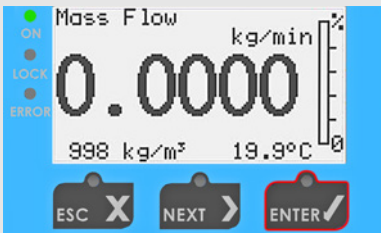

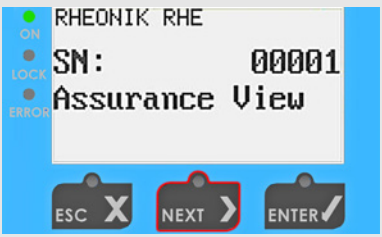
Alarm versions for digital outputs

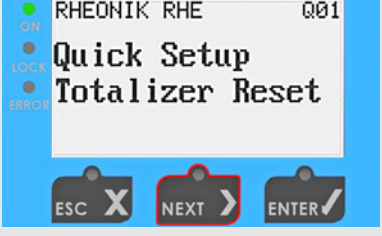
- Alarm Type
 - Set HI/Reset LO
The alarm signal jumps to 24 V above a freely selectable value. The alarm signal jumps to 0 V below the value.
 - In Band LO-HI
The alarm signal is 24 V within a freely selectable range. The alarm signal jumps to 0 V outside the range.
 - Out Band LO-HI
The alarm signal is 0 V within a freely selectable range. The alarm signal jumps to 24 V outside the range.
- Alarm Limit Low
The alarm signal is output if a freely selectable value is undershot.
- Alarm Limit High
The alarm signal is output if a freely selectable value is exceeded.

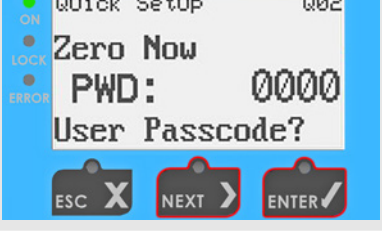
8.3.8 Configuring digital inputs

Display shows	Steps to take	Note
	Press the ENTER key once.	

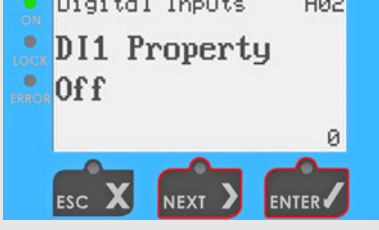
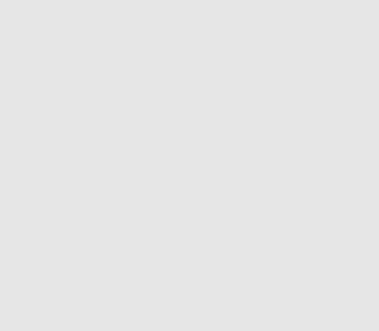
Display shows	Steps to take	Note
	Press the NEXT key 2 times.	
	Press the ENTER key once.	
	Press the NEXT key 3 times.	
	Press the ENTER key once.	
	Enter the user password using the NEXT and ENTER keys.	→ <i>'Entering the password (PWD)' on page 51</i>
	Press the NEXT key 2 times.	

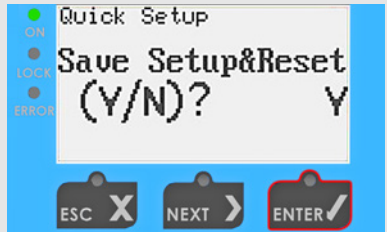

Display shows	Steps to take	Note
	<p>Press the ENTER key once.</p>	
	<p>Select the input you need by pressing the NEXT key and confirm your entry by pressing the ENTER key.</p>	<p>Selection (depends on the device configuration):</p> <ul style="list-style-type: none"> ■ DI1 Property ■ DI2 Property
	<p>Select the setting you need by pressing the NEXT key and confirm your entry by pressing the ENTER key.</p>	<p>Settings selection:</p> <ul style="list-style-type: none"> ■ Start Zero LO-HI ■ Start Zero HI-LO ■ Reset Tot LO-HI ■ Reset Tot HI-LO ■ Stp/Strt Tot L-H ■ Stp/Strt Tot H-L ■ Spec. Fct 1 L-H ■ Spec. Fct 1 H-L ■ Batch Stop LO-HI ■ Batch Stop HI-LO ■ Batch Restrtr L-H ■ Batch Restrtr H-L ■ Tot Reset&Hold L-H ■ Tot Reset&Hold H-L ■ Off
	<p>Press the ESC key 3 times.</p>	
	<p>Press the NEXT key once.</p>	<p>Select "Y" to save the changes.</p>



Display shows	Steps to take	Note
	Press the ENTER key once.	The display returns to the default view.

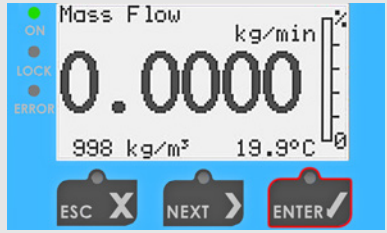
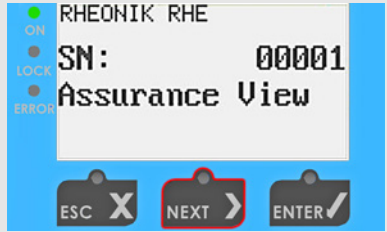

Tab. 23: Configuring a digital input

8.3.9 Performing an output test

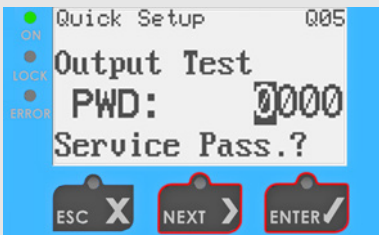
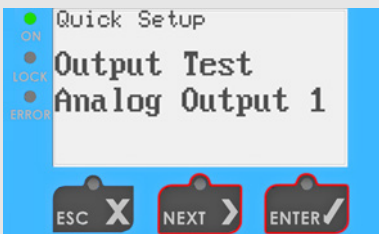
The output test enables you to check the output signals of the analogue and digital outputs of the RHE42 Coriolis transmitter.

Display shows	Steps to take	Note
	Press the ENTER key once.	
	Press the NEXT key 2 times.	
	Press the ENTER key once.	
	Press the NEXT key 4 times.	

Display shows	Steps to take	Note
	<p>Press the ENTER key once.</p>	
	<p>Enter the service password 5678 using the NEXT and ENTER keys.</p>	<p>↪ <i>'Entering the password (PWD)' on page 51</i></p>
	<p>Select the output you wish to test by pressing the NEXT key and confirm your entry by pressing the ENTER key.</p>	<p>Selection (depends on the device configuration):</p> <ul style="list-style-type: none"> ■ Analogue Output 1 ■ Analogue Output 2 ■ Digital Output 1/A (only if a frequency output has been configured) ■ Digital Output 2/B (only if a frequency output has been configured) ■ Digital Output 3 ■ Digital Output 4
	<p>Press the ENTER key once to start the output test.</p> <p>Select the sub-menu you need by pressing the NEXT key and confirm your entry by pressing the ENTER key.</p>	<p>When you start the output test, the following sub-menus will be available for selection depending on the output in question:</p> <ul style="list-style-type: none"> ■ Test calib. val (Analogue Output) ■ Enable test. (Digital Output)
	<p>Once the test is complete, select the output that was tested again and confirm your entry by pressing the ENTER key.</p>	<p>After selecting the sub-menu you need and confirming your entry, you can set the output value by pressing the NEXT and ENTER keys.</p>

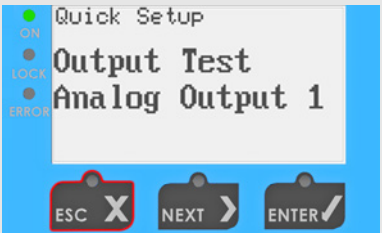
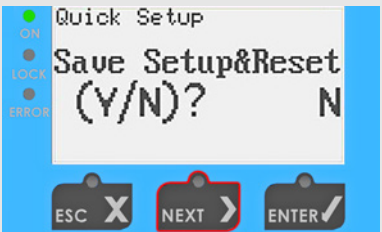
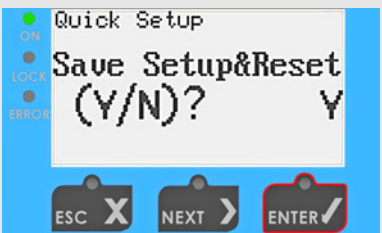
Display shows	Steps to take	Note
	Press the ENTER key once.	
	Press the ENTER key once.	The test is ended.
	Press the ESC key 2 times.	
	Press the NEXT key once.	Select "Y" to save the changes.
	Press the ENTER key once.	The display returns to the default view.

Tab. 24: Performing an output test



9 Operation, operating modes, using the device



For a detailed description of how to operate the RHE42 Coriolis transmitter, please see the RHE 40 desktop reference (operation manual).

The RHE 40 desktop reference is available to download from the Rheonik Messtechnik GmbH website: [↗ https://rheonik.com](https://rheonik.com).

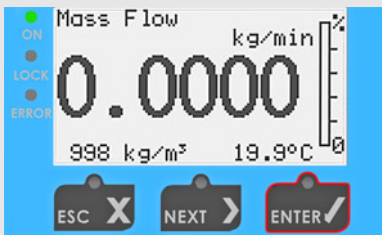
9.1 Resetting the mass flow and volume meters

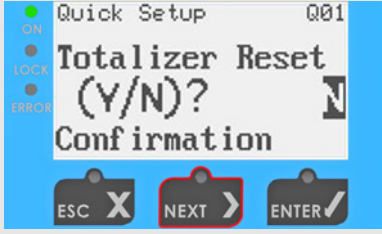
In the RHE42 Coriolis transmitter, the mass flow and volume meter readings are stored in a non-volatile memory, and are retained during restarts and if the RHE42 Coriolis transmitter is not energised. However, the meter readings can be reset either on the RHE42 Coriolis transmitter or using interfaces.

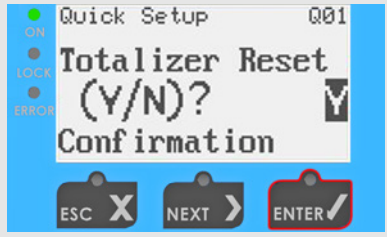
Display shows	Steps to take	Note
	Press the ENTER key once.	
	Press the NEXT key 2 times.	
	Press the ENTER key once.	
	Press the ENTER key once.	
	Press the NEXT key once.	

Display shows	Steps to take	Note
	Press the ENTER key once.	
	Press the ESC key once.	The display returns to the default view.

Tab. 25: Resetting the meters

9.2 Adjusting the display settings

The display settings enable you to configure the following:

- Default view for the display
- Display illumination
- Colour settings for error messages

Display shows	Steps to take	Note
	Press the ENTER key once.	
	Press the NEXT key 2 times.	
	Press the ENTER key once.	

Display shows	Steps to take	Note
	<p>Press the NEXT > key 7 times.</p>	
	<p>Press the ENTER ✓ key once.</p>	
	<p>Enter the user password using the NEXT > and ENTER ✓ keys.</p>	<p>→ <i>'Entering the password (PWD)' on page 51</i></p>
	<p>Select the setting you need by pressing the NEXT > key and confirm your entry by pressing the ENTER ✓ key.</p>	<p>Settings selection:</p> <ul style="list-style-type: none"> ■ Default Screen For selecting the measured value that should be displayed in the default view. 'Mass Flow' is pre-set ex works. ■ Lighting Config. <ul style="list-style-type: none"> – Permanent on (permanently illuminated) – Set on-time (illumination period after the user operates the device) – On at flow (illuminated when the device is recording a flow) ■ Background Color <ul style="list-style-type: none"> – Namur Colors (four-stage traffic light colours) – White / Off only (illuminated whilst the user is operating the device) – Assurance Level (detailed information on the Assurance Level is provided in the RHE 40 desktop reference)

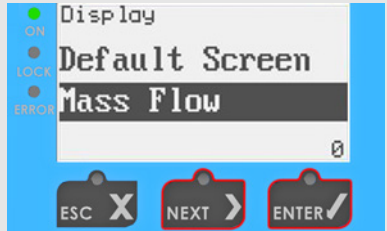
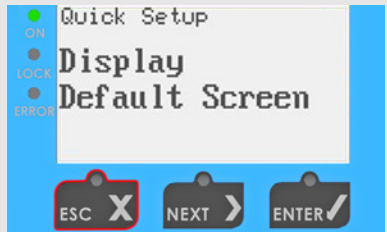
Display shows	Steps to take	Note
	Select the start view or the display lighting by pressing the NEXT key and confirm your entry by pressing the ENTER key.	
	Press the ESC X key 2 times.	The display returns to the default view.

Tab. 26: Adjusting the display settings



Namur Color Code

The Namur Color Code is a defined set of traffic light colours for colour-coding the various system states. Four colours are used on the RHE42 Coriolis transmitter:

- White (OK)
- Yellow (warning)
- Red (error)
- Violet (incorrect configuration)







9.3 Setting the filter

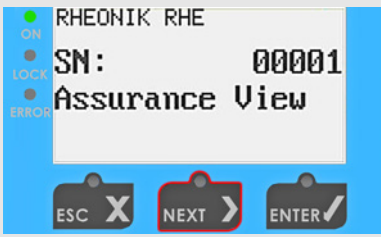

The **Filter Settings** menu enables you to set the stability of the measured values and the response time of the measuring device. Whilst increasing the filter values will result in more stable measured values, it will also extend the measuring device’s response time.

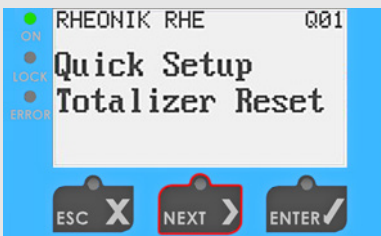
To ensure the medium is filled quickly, use the lowest possible filter values.

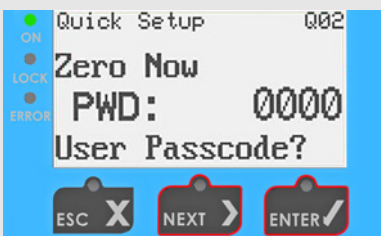
In contrast, higher filter values can be used for long-term measurements in order to optimally stabilise the measured values.

Display shows	Steps to take	Note
	Press the ENTER key once.	

Display shows	Steps to take	Note
	Press the NEXT key 2 times.	
	Press the ENTER key once.	
	Press the NEXT key 5 times.	
	Press the ENTER key once.	
	Enter the user password using the NEXT and ENTER keys.	→ <i>'Entering the password (PWD)' on page 51</i>
	Select the menu you need by pressing the NEXT key and confirm your entry by pressing the ENTER key.	Settings selection: <ul style="list-style-type: none"> ■ Display Filter ■ Freq. Out Filter ■ Ana 1 Out Filter ■ Ana 2 Out Filter ■ Modbus Filter

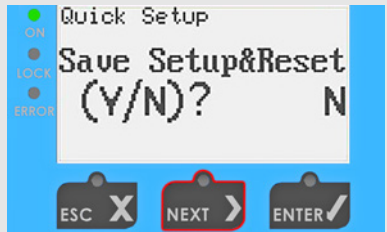
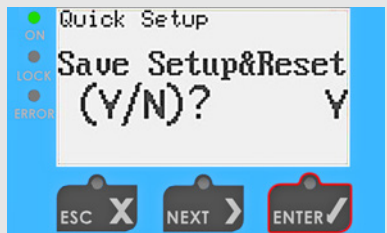
Display shows	Steps to take	Note
	<p>Select the value you need by pressing the NEXT > key and confirm your entry by pressing the ENTER ✓ key.</p>	
	<p>Press the ESC X key 2 times.</p>	
	<p>Press the NEXT > key once.</p>	<p>Select "Y" to save the changes.</p>
	<p>Press the ENTER ✓ key once.</p>	<p>The display returns to the default view.</p>

Tab. 27: Setting the filter using "Display Filter" by way of example

10 Servicing, maintenance

RHE42 Coriolis transmitters and the associated RHM Coriolis sensors do **not** require regular maintenance. Under normal operating conditions, there is also no need to calibrate the flow.

If required by law or for operational reasons, you can calibrate the flow as a one-off or at regular intervals as follows:

- On-site calibration against a reference meter or reference measuring system
- In a calibration laboratory

The local regulations or contractual/operational requirements will determine what type of calibration work is required and how often it should be performed. Detailed information on calibrating the RHE42 Coriolis transmitter can be found in the RHE 40 desktop reference. To ensure that the measuring accuracy remains consistent and within the permissible tolerance, we recommend regularly checking the calibration of the zero point; see: → [Chapter 8.3.1 'Calibrating the zero point' on page 54](#). The density measurements of an RHE42 Coriolis transmitter can be calibrated on site. For instructions on how to do this, please see the relevant section in the RHE 40 desktop reference.

10.1 Reading out the Assurance Factor and displaying the Assurance View

The Assurance Factor and Assurance View provide information about the status of the RHE42 Coriolis transmitter.

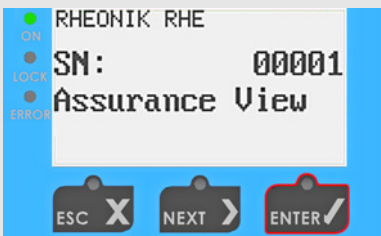
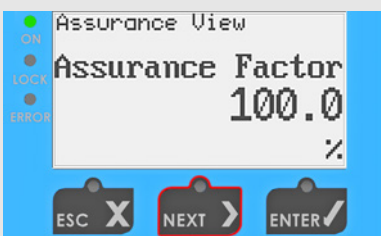
Display shows	Steps to take	Note
	Press the ENTER key once.	
	Press the ENTER key once.	
	Press the NEXT key once to switch to the Assurance View 1 display.	<p>Assurance Factor</p> <p>This feature is only available on devices that come with the advanced diagnostics package (Assurance Factor) AF.</p> <p>A percentage of less than 70 will impair the measurement.</p>

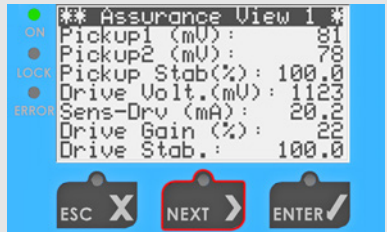
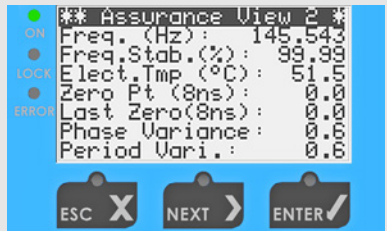
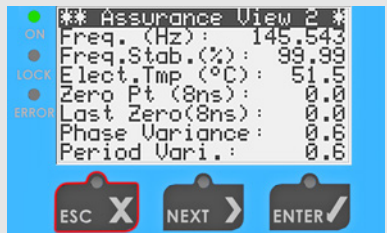
Display shows	Steps to take	Note
	Press the NEXT key to switch to the Assurance View 2 display.	Assurance View 1 Pickup1 (mV): 75-135 mV Pickup2 (mV): 75-135 mV Pickup Stab (%): At least 90% Drive Stab.: At least 90%
		Assurance View 2 Freq. Stab.: At least 90%
	Press the ESC key 2 times.	The display returns to the default view.

Tab. 28: Reading out the Assurance Factor and displaying the Assurance View

10.2 Reading out the zero point

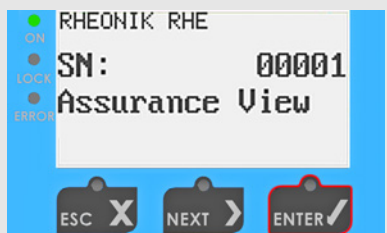
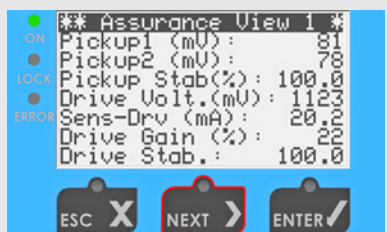
Transmitter display shows	Steps to take	Note
	Press the ENTER key once.	
	Press the ENTER key once.	
	Depending on the functions installed, press the NEXT key either 2 times or 3 times to switch to the Zero Point Hist. display.	

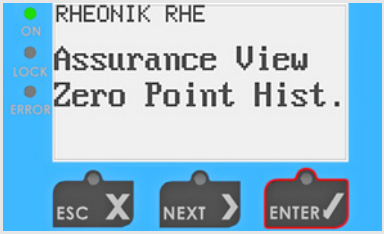
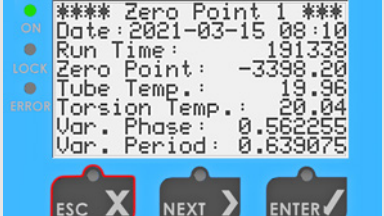
Transmitter display shows	Steps to take	Note
	<p>Press the ENTER key to switch to the Zero Point 1 display.</p>	<p>You can read out the last 10 zero points by pressing the NEXT key.</p>
	<p>Press the ESC X key 2 times.</p>	<p>The display returns to the default view.</p>

Tab. 29: Reading out the zero point

11 Displaying errors

Each status display shows a specific code, e.g. 0x00000000. Pressing the **ENTER** key will move the cursor through this code from right to left. The respective error bit or warning bit is explained at the lower edge of the display. Detailed assistance can be found in the section on **resolving errors (chapter 7)** in the RHE 40 desktop reference. This chapter contains comprehensive information to help you understand and resolve errors, warnings and connection problems relating to the RHE42 Coriolis transmitter. The RHECom software can also be used to read out error codes. Please see the RHECom quick guide.

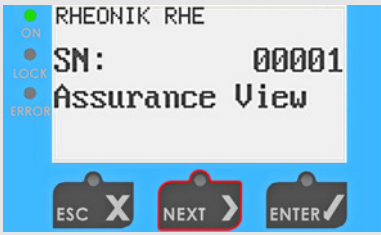
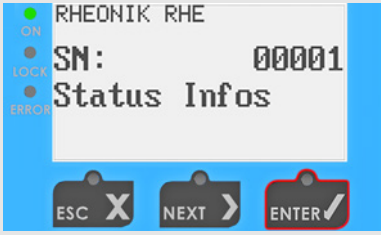
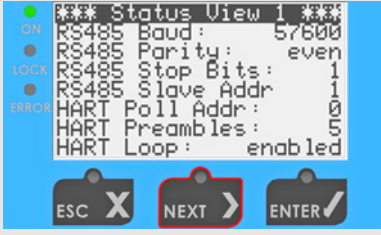
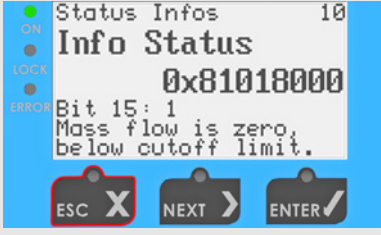
Display shows	Steps to take	Note
	Press the ENTER key once.	
	Press the NEXT key once.	
	Press the ENTER key once.	
	Press the NEXT key to display the various status displays.	Any active warnings and errors will be displayed directly after opening the "Status Infos" menu. To switch between the various status displays, repeatedly press the NEXT key.
		"Info Status" display

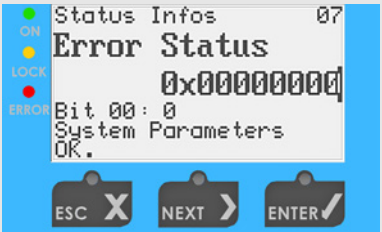
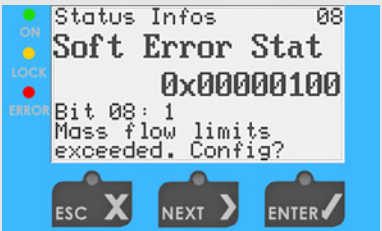
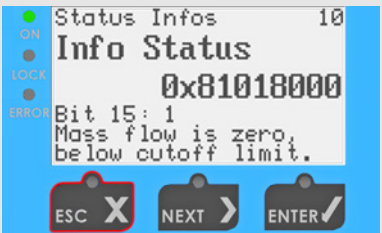
Display shows	Steps to take	Note
		"Soft Error" display
		"Error" display
	Press the ESC X key 2 times.	The display returns to the default view.

Tab. 30: Reading out error codes

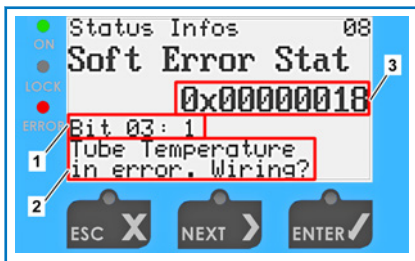



Fig. 24: RHExx_05.12.5_Reading out errors

- 1 Error bit or warning bit
- 2 Explanation of the error bit or warning bit
- 3 Error code or info code

 Pressing the **ENTER** key will move the cursor through the error code or info code (3) from right to left.

Bit	Description of error	Potential solution
0	Internal EEPROM error. After switching on the RHE42 Coriolis transmitter, inconsistencies were detected in the parameter memory and the parameters were reset to the default values. The system parameters need to be re-installed.	Please contact your Rheonik dealer.
1	The configuration of the 4-20 mA current output 1 is invalid.	Correct the settings and reset the RHE42 Coriolis transmitter.
2	The configuration of the pulse output is invalid.	Correct the settings and reset the RHE42 Coriolis transmitter.

Bit	Description of error	Potential solution
3	Timeout during the temperature measurement (no response).	Restart the system and contact your Rheonik dealer if the error persists.
4	Zero-point data lost.	Calibrate the zero point.
5	Internal totaliser data lost.	Reset the totaliser.
6	No response from the sensor interface.	Check the connection to the RHM Coriolis sensor and restart the RHE42 Coriolis transmitter. Please contact your Rheonik dealer if the error persists.
7	EEPROM data lost.	Perform a restart and check all set-up data, in particular the calibration information, if the error has been resolved. Please contact your Rheonik dealer if the error persists.
8	Error in the non-volatile memory.	Perform a restart and check all set-up data, in particular the calibration information, if the error has been resolved. Please contact your Rheonik dealer if the error persists.
9	Error in the density configuration.	Correct the settings and restart the RHE42 Coriolis transmitter.
10	The configuration of the 4-20 mA current output 2 is invalid.	Correct the settings and reset the RHE42 Coriolis transmitter.
11	The configuration of the 4-20 mA input (pressure/density) is invalid.	Correct the settings and reset the RHE42 Coriolis transmitter.
12	The automatic batch configuration is invalid.	Correct the settings and reset the RHE42 Coriolis transmitter.

Tab. 31: Error Status register

Bit	Description of error	Potential solution
1	Failed to read out the current output (hardware fault at the 4-20 mA analogue output).	Please contact your Rheonik dealer.
2	Pulse output range exceeded (possible configuration error).	Correct the settings of the pulse output and reset the RHE42 Coriolis transmitter.
3	Error when reading the tube temperature (possible hardware/wiring fault).	Check the connection to the RHM Coriolis sensor and restart the RHE42 Coriolis transmitter. Please contact your Rheonik dealer if the error persists.
4	Error when reading the torsion axis temperature (possible hardware/wiring fault).	Check the connection to the RHM Coriolis sensor and restart the RHE42 Coriolis transmitter. Please contact your Rheonik dealer if the error persists.
5	Error when reading the transmitter temperature (possible hardware fault).	Please contact your Rheonik dealer.

Bit	Description of error	Potential solution
6	Internal hardware fault in connection with the temperature measurement.	Please contact your Rheonik dealer.
7	Mass flow alarm value exceeded (possible configuration error).	Correct the settings and restart the RHE42 Coriolis transmitter if the measured mass flow value is correct.
8	Mass flow alarm value exceeded (possible configuration error).	Correct the settings and restart the RHE42 Coriolis transmitter if the measured mass flow value is correct.
9	Volumetric flow alarm value exceeded (possible configuration error).	Correct the settings and restart the RHE42 Coriolis transmitter if the measured volumetric flow value is correct.
10	Zero-point calibration unsuccessful (possible sensor instability).	Restart the zero-point calibration. Please contact your Rheonik dealer if the error persists.
11	Current input value of the analogue input (pressure/density) exceeded.	Check the external device that has been connected.
12	Sensor signals outside the expected ranges. May occur during start-up (possible hardware fault).	Check the connection to the RHM Coriolis sensor and restart the RHE42 Coriolis transmitter. Please contact your Rheonik dealer if the error persists.
13	The RHE42 Coriolis transmitter detects a sensor frequency that is out of range. May occur during start-up (possible hardware fault).	Check the connection to the RHM Coriolis sensor and restart the RHE42 Coriolis transmitter. Please contact your Rheonik dealer if the error persists.
14	The RHE42 Coriolis transmitter detects a sensor phase that is out of range. May occur during start-up (possible hardware fault).	Check the connection to the RHM Coriolis sensor and restart the RHE42 Coriolis transmitter. Please contact your Rheonik dealer if the error persists.
17	The RHE42 Coriolis transmitter detects a sensor amplitude that is out of range. May occur during start-up (possible hardware fault).	Check the connection to the RHM Coriolis sensor and restart the RHE42 Coriolis transmitter. Please contact your Rheonik dealer if the error persists.
18	RHE42 Coriolis transmitter firmware error (possible hardware fault).	Restart the RHE42 Coriolis transmitter. Please contact your Rheonik dealer if the error persists.
19	RHE42 Coriolis transmitter firmware/hardware self-test error (possible hardware fault).	Restart the RHE42 Coriolis transmitter. Please contact your Rheonik dealer if the error persists.
20	Error in the flash memory used for calibrating the zero point.	Calibrate the zero point. Please contact your Rheonik dealer if the error persists.
21	Error in the flash memory used for the totalisers.	Reset the totalisers. Please contact your Rheonik dealer if the error persists.

Bit	Description of error	Potential solution
22	RHM Coriolis sensor not ready yet. May occur during start-up.	Check the connection to the RHM Coriolis sensor and restart the RHE42 Coriolis transmitter. Please contact your Rheonik dealer if the error persists.
24	Inconsistent calibration data for the 4-20 mA analogue input.	Please contact your Rheonik dealer.
25	Measurement signal below defined threshold; a multi-phase flow is possible.	Ensure there is a single-phase flow or activate the Partly Filled Pipe Manager; see RHE 40 desktop reference.

Tab. 32: Soft Error register

Bit	Cause	Potential solution
0	Upper warning limit for the density exceeded.	Check the upper warning limit for the density measurement as set by the user.
1	Upper warning limit for the mass flow exceeded.	Check the upper warning limit for the mass flow measurement as set by the user.
2	Upper warning limit for the volumetric flow exceeded.	Check the upper warning limit for the volumetric flow measurement as set by the user.
3	Upper warning limit for the tube temperature exceeded.	Check the upper warning limit for the tube temperature measurement as set by the user.
4	Upper warning limit for the torsion axis temperature exceeded.	Check the upper warning limit for the torsion axis temperature measurement as set by the user.
8	Upper warning limit for the mass totaliser exceeded.	Check the upper warning limit for the mass totaliser as set by the user.
9	Upper warning limit for the volume totaliser exceeded.	Check the upper warning limit for the volume totaliser as set by the user.
11	Pressure warning range exceeded.	Check the warning range for the pressure input as set by the user.
15	Range set for the 4-20 mA current output 1 exceeded.	Check the range for the 4-20 mA current output 1 as set by the user.
16	Lower warning limit for the density undershot.	Check the lower warning limit for the density measurement as set by the user.
17	Lower warning limit for the mass flow undershot.	Check the lower warning limit for the mass flow measurement as set by the user.
18	Lower warning limit for the volumetric flow undershot.	Check the lower warning limit for the volumetric flow measurement as set by the user.
19	Lower warning limit for the tube temperature undershot.	Check the lower warning limit for the tube temperature measurement as set by the user.
20	Lower warning limit for the torsion axes undershot.	Check the lower warning limit for the torsion axis temperature measurement as set by the user.

Bit	Cause	Potential solution
21	Range set for the 4-20 mA current output 2 exceeded.	Check the range for the 4-20 mA current output 2 as set by the user.
24	Lower warning limit for the mass totaliser undershot.	Check the lower warning limit for the mass totaliser as set by the user.
25	Lower warning limit for the volume totaliser undershot.	Check the lower warning limit for the volume totaliser as set by the user.
26	Multi-phase flow identified.	Ensure there is a single-phase flow or activate the Partly Filled Pipe Manager; see RHE 40 desktop reference.
29	RHE42 Coriolis transmitter software error; possible hardware fault.	Restart the RHE42 Coriolis transmitter. Please contact your Rheonik dealer if the error persists.
30	Density gradient exceeds set threshold.	Please contact your Rheonik dealer.
31	Mass flow gradient exceeds set threshold.	Please contact your Rheonik dealer.

Tab. 33: Warnings register

12 Technical data

Housing material	Powder-coated aluminium	
Housing classification	IP65 / Type 4 or IP66 / Type 4 (depending on order code) Optionally: IP66/IP67 / Type 6 (declared by manufacturer)	
Ambient temperature	-20 – +60°C (-4 – +140°F), optionally -40 – +65°C (-40 – +149°F)	
Relative humidity	0 – 95% (non-condensing)	
Housing dimensions	144 x 108 x 139 mm (5.67 x 4.25 x 5.47 in)	
User interface and design	Local display with keys High-contrast LCD display with backlight and 3 control keys. Configured either locally or using the RHECom software. Display visibility reduces at temperatures below -10°C.	No display No local control options. Configured using the RHECom software.
Connection to sensor	Integrated on the RHM Coriolis sensor or with a 3 or 10 m cable for remote installation (ARHE-Cx)	
Cable inlets	2 x ½ inch NPT for current and I/O	
Computer connection	Via Modbus RTU to the PC	
Totalisers	6 x resettable forwards, backwards and net totalisers for the mass and volume 2 x non-resettable totalisers for the mass and volume	
Analogue outputs	Up to 2 x 4-20 mA outputs, active or passive Intrinsically safe versions available	
Pulse/frequency/status outputs	Up to 2 configurable pulse/frequency/status outputs (IEC 60946) (max. 10 kHz) Intrinsically safe versions available (Open Collector)	
Digital inputs	Up to 2 configurable control inputs (IEC 60946) Intrinsically safe versions available	
Digital data communication	HART, Modbus RTU, Ethernet (Modbus TCP / IPv4), Foundation Fieldbus FFH1 (FISCO), Profibus PA	
Power supply	12 – 24 V DC ±10%, 2 W is typical (max. 4 W)	
Approvals for hazardous areas	ATEX/IECEX and CSA US-Can	

Tab. 34: Technical data

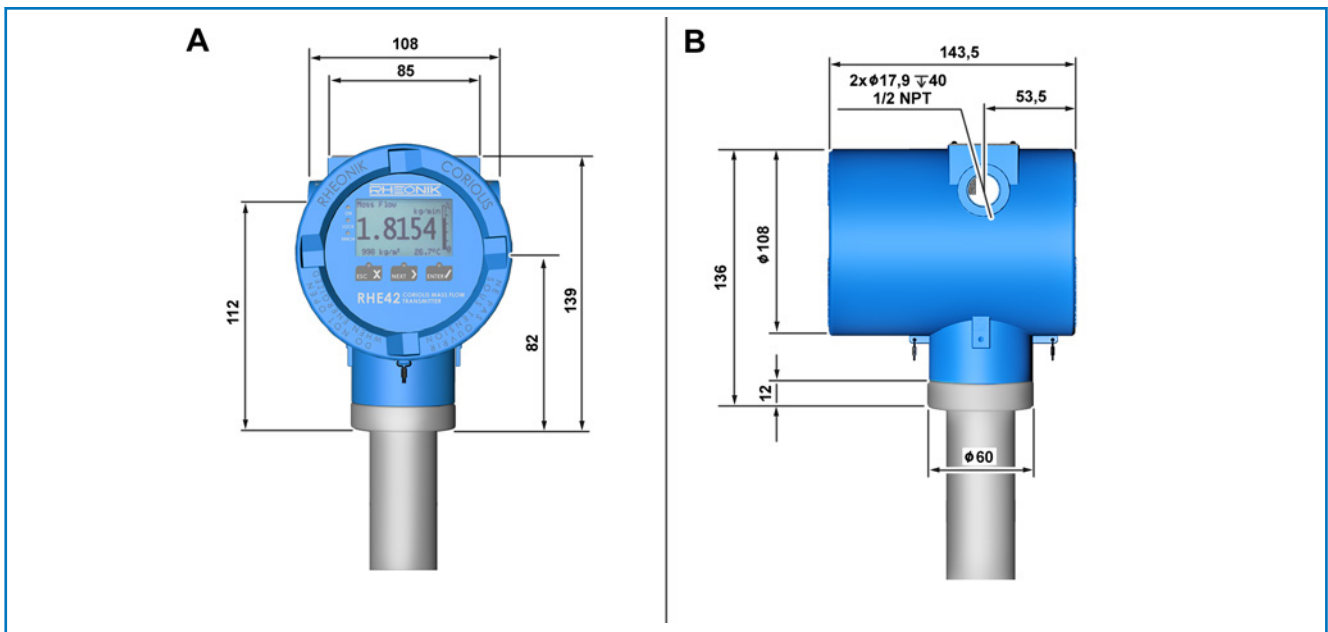

Fig. 25: Dimensions of the RHE42 Coriolis transmitter (RHE42-C*)

- A Front view
- B Side view

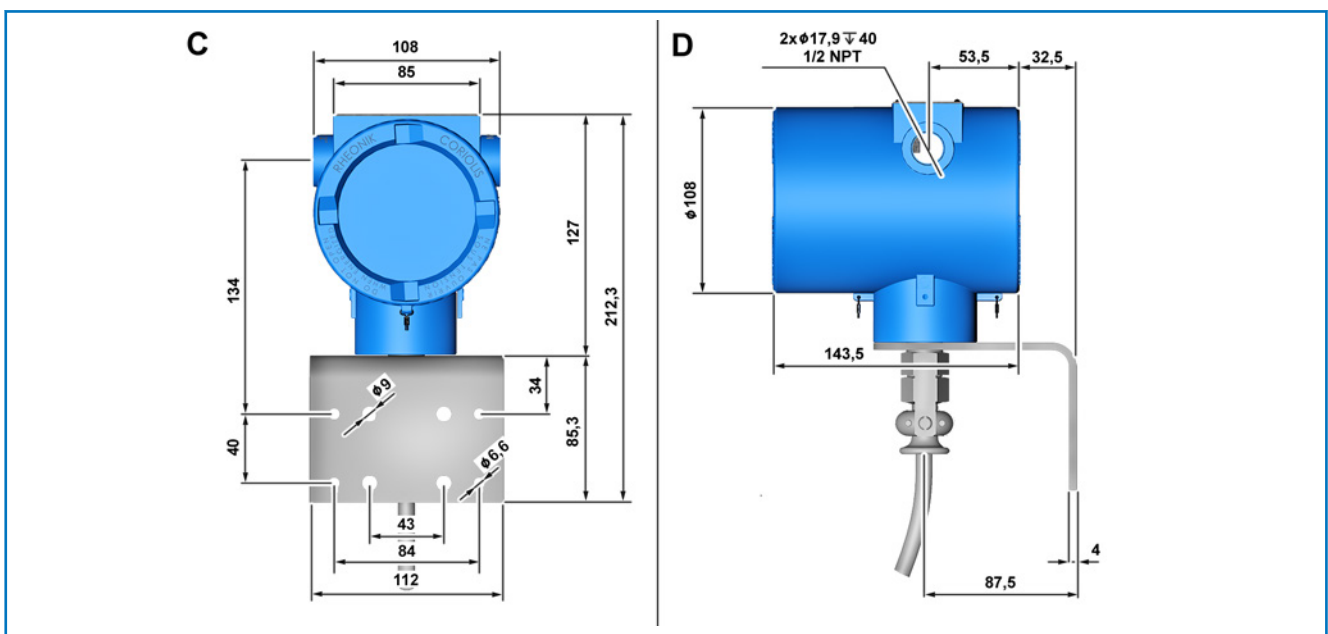

Fig. 26: Dimensions of the RHE42 Coriolis transmitter (RHE42-R*)

- C Rear view
- D Side view

13 Returns and disposal

Returns

Do not ship any measuring devices if you are unsure whether you have been able to fully remove harmful substances, e.g. substances that have penetrated into cracks/crevices or diffused through plastic.

If the measuring device has been inadequately cleaned, any costs incurred for disposal or personal injury (e.g. chemical burns) will be charged to the device operator.

Disposal

The RHE42 Coriolis transmitters are not subject to the WEEE Directive 2012/19/EU on the prevention of waste electrical and electronic equipment and the reduction of this waste through reuse, recycling and other forms of recovery.

The RHE42 Coriolis transmitters comply with EU Directive 2011/65/EU on the restriction of the use of certain hazardous substances in electrical and electronic equipment.

Observe the regulations in force in your country!

14 Appendix A: Ex-Safety Instructions (product approval information)

Safety instructions for the installation in a hazardous area

- The measurement system shall be installed & maintained according to the applicable standards regarding electrical installations in hazardous areas.
- Before installation, read carefully the operating manual of the RHE42 Coriolis transmitter.
- The mounting, electrical installation, commissioning and maintenance are to be carried out by qualified personal only who are trained in explosion protection.
- All national regulations concerning the installation, maintenance and repair of instruments in explosion hazardous areas must be observed.
- The sensor cable connection (ARHE-C4) between the RHM Coriolis sensor and the RHE42 Coriolis transmitter is intrinsically safe.
- For safety reasons, the total length of the cable connection (ARHE-C4) between the RHM Coriolis sensor and RHE42 Coriolis transmitter must not exceed 20 metres.
- The connection cables (ARHE-C4/ARHE-C6) are specified for -50 to +105 °C. Temperatures above must be avoided. Temporary temperatures below -50 °C are allowed, if the connection cable is fed in a protecting tube.
- Always close unused cable glands and openings with certified dummy plugs.
- When installed in the hazardous area the RHE42 Coriolis transmitter must not be opened with any power connection alive or when hot.
- The USB interface must not be used in hazardous areas.
- In accordance with details indicated on the type label, the equipment may be used under conditions where ignitable atmospheres composed of a mixture of air and other gases, steam or dust are present. The equipment is not suitable for mines.
- The RHE42 Coriolis transmitter is available for zone 1 or 2, zone 21 or 22, for div. 1 or div. 2 and for ordinary locations. Refer to the type label of the RHE42 Coriolis transmitter for the individual classification.
- In zone 21 or 22 the RHE42 has to be installed in such a way that process-related electrostatic charges, e.g. caused by media passing by, can be excluded.
- Regarding the installation of the RHM Coriolis sensor refer to the corresponding manual.





WARNING

Risk of explosion!

Substitution of components may impair intrinsic safety.

Avertissement!

La substitution de composants peut compromettre la sécurité intrinsèque.

	WARNING
	<p>Risk of explosion! Do not open when energized!</p> <p>Avertissement! Ne pas ouvrir sous tension!</p>
	WARNING
	<p>Risk of explosion! Read the manual before connecting or operating the unit!</p>

System description

A Rheonik Coriolis mass flow meter system for hazardous areas consists of an RHM Coriolis sensor and an RHE42 Coriolis transmitter. The barrier required for an intrinsically safe RHM Coriolis sensor is part of the certified RHE42 Coriolis transmitter.

An intrinsically safe RHM Coriolis sensor can – depending on the individual certification – be installed in zone 0, zone 1 or zone 2. For the American market versions for div. 1 and for div 2 are available.

The RHE42 Coriolis transmitter is an associated equipment and contains the barriers for the RHM Coriolis sensor to be connected.

Code	Can be installed in	Certified according to/by
A1, AA	Zone 1, 2; safe area	ATEX, IECEx
A2, AB	Zone 2; safe area	ATEX, IECEx
AD	Zone 21, 22; safe area	ATEX, IECEx
AS	Safe area	ATEX, IECEx
C1	Zone 0, 1, 2; Div. 1, 2; safe area	CSA/ETL, for USA and Canada
C2	Zone 2; Div. 2; safe area	CSA/ETL, for USA and Canada
CD	Zone 20, 21, 22; Div. 1, 2; safe area	CSA/ETL, for USA and Canada
CS	Safe area	CSA/ETL, for USA and Canada

Tab. 35: Overview locations, depending on its certification

Electrical safety limits

Signal	Terminals	Type	Nominal Voltage	Um
DC supply	20 (+24 V) + 21 (GND)	Supply	12 – 24 V (±10 %)	30 V
Supply for analog out	50 (+24 V) + 57 (GND)	Supply out	24 V ¹⁾	30 V
Digital Out	31 + 37, 32 + 37, (40 + 41, 42 + 43 OC)	Out	24 V ²⁾	30 V
Analog Out	51 + 52, 53 + 54	Passive out	24 V	30 V

Signal	Terminals	Type	Nominal Voltage	Um
Digital In	35 + 37, 36 + 37, (46 + 47 floating)	In	24 V	30 V
RS485	70 + 71	Interface	70 to 71: ±5 V 70, 71 to PE: 30 V ³⁾	30 V
Ethernet	73 – 76	Interface	±2.5 V	30 V
FF, PA	77 + 78	Interface	24 V	30 V
USB	Connector	Interface	5 V	30 V

¹⁾ Directly connected to terminal 20 (+24 V supply input).

²⁾ A short circuit to any voltage between 0 and 30 V should be avoided, but will not damage the output.

³⁾ The nominal signal Voltage between 70 and 71 is 3,3 V. The interface is floating but clamped to PE with a clamping voltage of 30 V.

Tab. 36: Power supply and I/O (all RHE42 except RHE42-****D1- **YY-A***-***** with YY = I*, F*, P*)

Signal	Terminals	Type	Nominal Voltage	Um
DC supply	20+21	Supply	12 – 24V (±10 %)	30 V
RS485	70+71	Interface	70 to 71: ±5 V; 70 or 71 to PE: 30 V	30 V
USB	(Connector)	Interface	5 V	30 V

Tab. 37: Power supply and RS485 (Only RHE42-****D1- **YY-A***-***** with YY = I*, F*, P*), intrinsically safe I/O)

Applied voltages above the nominal voltage may damage the corresponding input or output but will not affect the safety on the connection to the IS RHM. Voltages above the Um values must be avoided.

Circuit name	Terminals	Ui [V]	Ii [mA]	Pi [mW]	Li [mH]	Ci [nF]
4 – 20 mA out (AO)	51 + 52, 53 + 54	30	100	750	< 0,1	negligible
Digital out OC (DO)	40 + 41, 42 + 43	30	50	375	negligible	negligible
Digital out NAMUR (DO)	44 + 45, 48 + 49	15	20	75	negligible	negligible
Digital in (DI)	46 + 47	30	50	375	negligible	negligible
FFH1 (FISCO) (FF oder PA)	77 + 78	FISCO field device				

Tab. 38: Intrinsically safe I/O terminals (only RHE42-**E**D1- **YY-A***-***** with YY = I*, F*, P*)

Depending on the I/O code, terminals 40–41 or 44–45 and 42–43 or 46–47 or 48–49 or 77–78 are present.

Units with FFH1 foundation fieldbus or Profibus PA interface are suitable for the use in FISCO systems according to IEC 60079-25. (RHE42-****D1- **P*-A***-**** or RHE42-****D1- **P*-A***-****).

Circuit name	Cable colors	U _o [V]	I _o [mA]	P _o [mW]	L _o [mH]	C _o [nF]
Drive circuit (DVR)	Brown + blue	8.1	136	275	1.9 ¹⁾	2000
Temp. sense (TE)	Red + pink/ orange + pink	6.5	45,7 ²⁾ 3)	74,3 ³⁾	1	2000
Pickup circuit (PU)	Yellow + green/ white + gray	2.4	9.0	5.4	100	2000

¹⁾ 7,5 mH for sensors RHM certified for gas group IIB/group C and D.

²⁾ PtP (red) and PtT (orange) share a common ground PtG (pink). The maximum current on the pink wire therefor is 91,4 mA (IECEX) or 87,6 mA (CSA).

³⁾ CSA certified units: I_o = 43.8mA, P_o = 71.2mW

The circuit names in parenthesis are used on the label on the RHE42.

Tab. 39: Intrinsically safe circuits for RHM

Thermal safety limits

The RHE42 Coriolis transmitter with the Ex code A1, AA, A2, AB, C1 or C2 have the temperature class T6, with AD and CD temperature class T85°C.

If with the compact version (RHE42-C***-****-****-****) the fluid or gas temperature rises above 65 °C, temperature class and maximum ambient temperature are limited by the RHM Coriolis sensor. See RHM Coriolis sensor manual.

The RHE42 Coriolis transmitter with Ex-code AS or CS must be installed in the safe area, therefor no temperature class is specified for these units.

The ambient temperature must under no circumstances exceed the limits specified in chapter → *Technical data* on page 103.

Grounding and shielding

The RHE42 Coriolis transmitter must be grounded.

The minimum cross section of the ground wire is 2,5 mm². Wires with 2.5 mm² can be connected to the PE terminal 22 or to the M4 screw type terminal. Wires with a bigger cross section must be connected to the M4 screw type terminal.

If the RHE42 is not directly connected to a grounded metallic structure, it must be grounded with a cable with at least 4mm² cross section. The cable must be connected to the grounding screw via an Sn plated fork terminal or ring terminal (see fig. 6, 32, 33).

Shield between RHM Coriolis sensor and RHE42 Coriolis transmitter

IEC60079-0 recommends to ground shielded cables just on one end, normally outside the hazardous area. On the other side the shield may be grounded via a 1 nF capacitor. In small installations (cable length typically less than 10 m) the shield can be grounded on both sides, provided that there is no potential difference between PE at the RHM Coriolis sensor and PE at the RHE42 Coriolis transmitter. This can be assumed if there is a good metallic contact or if a dedicated PE cable of at least 4 mm² connects the two grounding points. Most RHM Coriolis sensor provide a PE terminal and terminal for grounding via 1 nF. If there is no capacitive ground, special measures might be required.

Power supply and I/O circuits

I/O and supply cables should be shielded when fed outside the control cabinet. When unshielded wires are used outside a building, dedicated surge suppressors must be used.



The intrinsically safe circuits for the RHM Coriolis sensor are connected to earth; along the intrinsically safe circuits potential equalization must exist.

Installation

All cable entries are for fixed installation only. Cables must be clamped close to RHE42 Coriolis transmitter and RHM Coriolis sensor to prevent pulling or twisting.

IECEX/ATEX

In zone 21 or zone 22 the RHE42 has to be installed in such a way that process-related electrostatic charges, e.g. caused by media passing by, can be excluded.

The RHE42 Coriolis transmitters have 2 threads NPT ½" for I/O and the power supply.

The installer must provide the certified cable glands and dummy plugs required and is responsible for the safe installation.

Cable glands are available upon request.

CSA

The RHE42 Coriolis transmitters have 2 threads NPT ½" for I/O and the power supply.

For RHE42 Coriolis transmitters with CSA certification C1 (div. 1), the installer must provide the required sealing fittings and is responsible for the safe installation.

For RHE42 Coriolis transmitters with CSA certification C2 (div. 2), the installer must provide the required cable glands and is responsible for the safe installation.

Cable glands and sealing fittings are available upon request.

Connection to RHM Coriolis sensor

All RHE42 Coriolis transmitter for remote installation (housing code R*) come with a fixed cable (up to 20 m) or an IS connection box for connecting the RHM Coriolis sensor.

For wiring information refer to chapter → *'Electrical connection to RHM Coriolis sensor (remote version only)' on page 101* and to the manual of the RHM Coriolis sensor.

RHE42 Coriolis transmitters for compact mount come readily connected to the corresponding RHM Coriolis sensor. Disassembling RHM Coriolis sensor and RHE42 Coriolis transmitter is only allowed for personnel authorized by Rheonik.

Special conditions for CSA certified units

1. ➤ Shall be installed in class I, Division 1/Zone 1 location.
2. ➤ Unused conduit openings shall be plugged with certified blanking components.
3. ➤ Conduit seal shall be installed within 50 mm from the enclosure.
Un scellement doit être installé moins des 50mm du boîtier.

**RHE42 Coriolis transmitter
marked Class I, Div. 1,
Group A, B, C, D
and/or Class I, Zone 1,
A/Ex db [ia Ga] IIC T6 Gb**

**RHE42 Coriolis transmitter
marked Class I, Div. 2,
Group A, B, C, D
and/or Class I, Zone 2,
A/Ex nA [ia Ga] IIC T6 Gc**

**RHE42 Coriolis transmitter
marked [Ex ia Ga]**

**Electrical connection of power
supply and I/O**

- 4.** → Potential equalization shall be provided along intrinsically safe circuits grounding.
- 1.** → Shall be installed in class I, Division 2/Zone 2 location.
No seal required.
- 2.** → Potential equalization shall be provided along intrinsically safe circuits grounding.
- 1.** → Shall be installed in ordinary (non-hazardous) location only.
- 2.** → Potential equalization shall be provided along intrinsically safe circuits grounding.

For maintaining $U_m = 30\text{ V}$ on power supply and I/O the installation must comply with at least one of the following points:

- The complete installation is an SELV or PELV system.
- All signals are isolated via an isolating transformer complying with the requirements of IEC 61558-2-6.
- All connected apparatus comply with IEC61010-1, IEC 60950 or IEC 62368-1.
- The complete installation is fed from cells or batteries.

Units with the I/O options "I*", "F*" and "P*" (intrinsically safe I/O) have a metal shield above the intrinsically safe I/O terminals. After connecting the I/O cable the shield must be refixed for providing the required clearance between the intrinsically safe and the standard terminals.

General

- National and local standards regarding electrical installations must be observed.
- For information regarding function and usage of the different I/O and supply circuits refer to the corresponding chapters of the main manual.
- The USB interface must not be connected and used in hazardous areas.
- The cage clamp terminals are located in the connection department of the housing. For proper connections the following requirements must be fulfilled:
 - Conductor cross-section: 0.2 – 2.5 mm²
 - Stripping length: 6 – 9 mm
- Stranded wires should be equipped with cable end sleeves.

Standard I/O

Standard I/O: When operating the 4 – 20 mA analog outputs with 24 V DC, a minimum load resistance of 500 Ω shall be used for limiting the internal power dissipation. With 12 V supply no dedicated output resistor is required.

Intrinsically safe I/O

Intrinsically safe I/O circuits must be operated via dedicated barriers or separation amplifiers complying with the limits listed in chapter → *'Electrical safety limits' on page 96.*

Electrical connection to RHM Coriolis sensor (remote version only)

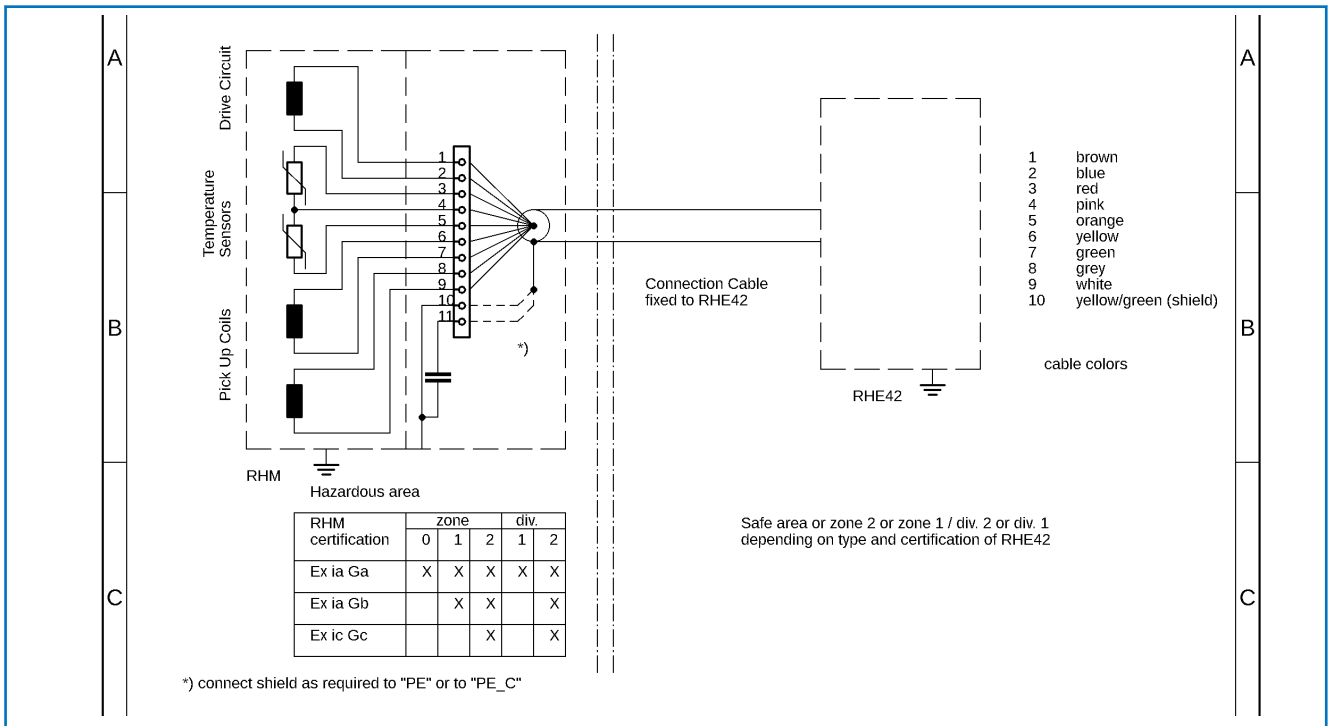

Fig. 27: Electrical connections between RHM Coriolis sensor *** -S * or -J * (terminal box) and RHE42 Coriolis transmitter

For proper connection of the shield to RHM terminal 10 or 11 refer to chapter "Grounding and shielding" on page 98.

For further information regarding the connections and the function of the different signals, please refer:

- Chapter 4 "Electrical Installation"
- RHM Coriolis sensor manual, Appendix A "Ex-safety instructions"

Ordering code

The following extract of the ordering code shows the information relevant for hazardous areas.

E42-EEPP-SS00-HHCC-000

Ordering code	Description
E42	RHE42 Coriolis transmitter
EE	Housing options
C*	Compact mount, aluminium housing
R* (except RR, RS, RT, R5)	remote mount, aluminium housing, fixed cable to RHM
RR, RS, RT	remote mount, stainless-steel housing, fixed cable to RHM
R5	remote mount, stainless-steel housing, connection box I/O and RHM

Ordering code	Description		
PP	Power supply options		
	D1	12 – 24 V (±10 %)	
SS	Software options		
OO	I/O configuration options ¹⁾		
	I*, F*, P*	up to 3 I/O signals (4 – 20 mA out, digital out, digital in, FF, ...), all IS	
	All others	up to 6 I/O signals, all non IS	
HH	Hazardous areas approvals		
	ATEX, IECEX:		
	A1	II 2(1)G Ex db eb [ia Ga] IIC T6 Gb	RHE42 Coriolis transmitter in zone 1 or 2 ²⁾
	AA	II 2(1)G Ex db eb [ia Ga] IIB T6 Gb	RHE42 Coriolis transmitter in zone 1 or 2 ²⁾
	A2	II 3(1)G Ex db ec [ia Ga] IIC T6 Gc	RHE42 Coriolis transmitter in zone 2 ²⁾
	AB	II 3(1)G EX db ec [ia Ga] IIB T6 Gb	RHE42 Coriolis transmitter in zone 2 ²⁾
	AD	II 2(1)D Ex tb [ia Da] IIIC T85°C Db	RHE42 Coriolis transmitter in Zone 21 or 22 ²⁾
	AS	II (1)G [Ex ia Ga] IIC and [Ex ia Da] IIIC	RHE42 Coriolis transmitter in safe area
	CSA/ETL (USA and Canada)		
	C1	Class I, Div. 1/Ex db [ia Ga] IIC T6 Gb	RHE42 Coriolis transmitter in zone 1 or 2, Div. 1 or 2 ²⁾
	C2	Class I, Div. 2/Ex db ec [ia Ga] IIC T6 Gc	RHE42 Coriolis transmitter in zone 2, Div. 2 ²⁾
	CD	Class II, Div. 1/Ex tb [ia Da] IIIC	RHE42 Coriolis transmitter in zone 21 or 22, Div. 1 or 2 ²⁾
	CS	[Ex ia Ga] IIC and [Ex ia Da] IIIC	RHE42 Coriolis transmitter in safe area
	CC	Measurement certifications	
OOO	Special options		
¹⁾ All versions provide one RS485 interface, non-IS. ²⁾ Temperature code reduced to T4 (135 °C) with I/O configuration F* and P*			

Not all combinations are possible. For available combinations see instructions. Where no versions for the place holders are specified, these parameters are not relevant for the Ex certification.

For the complete ordering code refer to the respective datasheets.

Technical data

Description	Value	Unit	Note
Operating temperatur	-20 (-40) – 65	°C	See type label
Relative humidity	10 – 95	%	Non-condensing
Altitude	3000	m	Higher maximum altitude upon request
Pollution degree	3	-	-
Installation category	I	-	-
Installation	-	-	Indoor and outdoor use

Tab. 40: Limits for safe operation

Electrical data, refer to chapter [↔ 'Electrical safety limits' on page 96](#) and to the informations on the type label.

For the complete technical data refer to chapter 12 "technical data".

Compliance

The RHE42 Coriolis transmitter certified according to ATEX/IECEX comply with the following standards for hazardous areas:

- IEC 60079-0
- IEC 60079-1
- IEC 60079-7
- IEC 60079-11

For the list of standards relevant for a certain unit and for the release date refer to the certificate.

The RHE42 Coriolis transmitter certified according to CSA/ETL comply with the following standards for hazardous areas:

- C22.2 No 61010-1: 2012
- UL 61010-1 3rd Ed.
- C22.2 No 30-M1986 (R2012)
- UL 1203, 5th Ed.: 2013
- C22.2 No 60079-0, 6th Ed.
- UL 60079-0, 6th Ed.
- C22.2 No 60079-1, 7th Ed.
- UL 60079-1 7th Ed.
- C22.2 No 60079-11, 6th Ed.
- UL 60079-11, 6th Ed.
- C22.2 No 213/ANSI/ISA 12.12.01: 2017
- C22.2 No 60529 Ed. 2.2
- ANSI/ISA 60529 Ed. 2.2
- C22.2 No. 94 - 20
- UL 50E - 20

For the list of standards relevant for a certain unit and for the release date refer to the certificate.

Service and repair

The unit does not contain any user serviceable parts.

If the unit gets modified in any way, the Ex-certification gets void.
In case of malfunction connect your dealer or directly Rheonik Messtechnik GmbH.

Contact address

Rheonik Messtechnik GmbH
Rudolf-Diesel-Str. 5
85235 Odelzhausen Germany
➔ <https://www.rheonik.com>
➔ info@rheonik.com

15 Appendices

Wiring diagrams

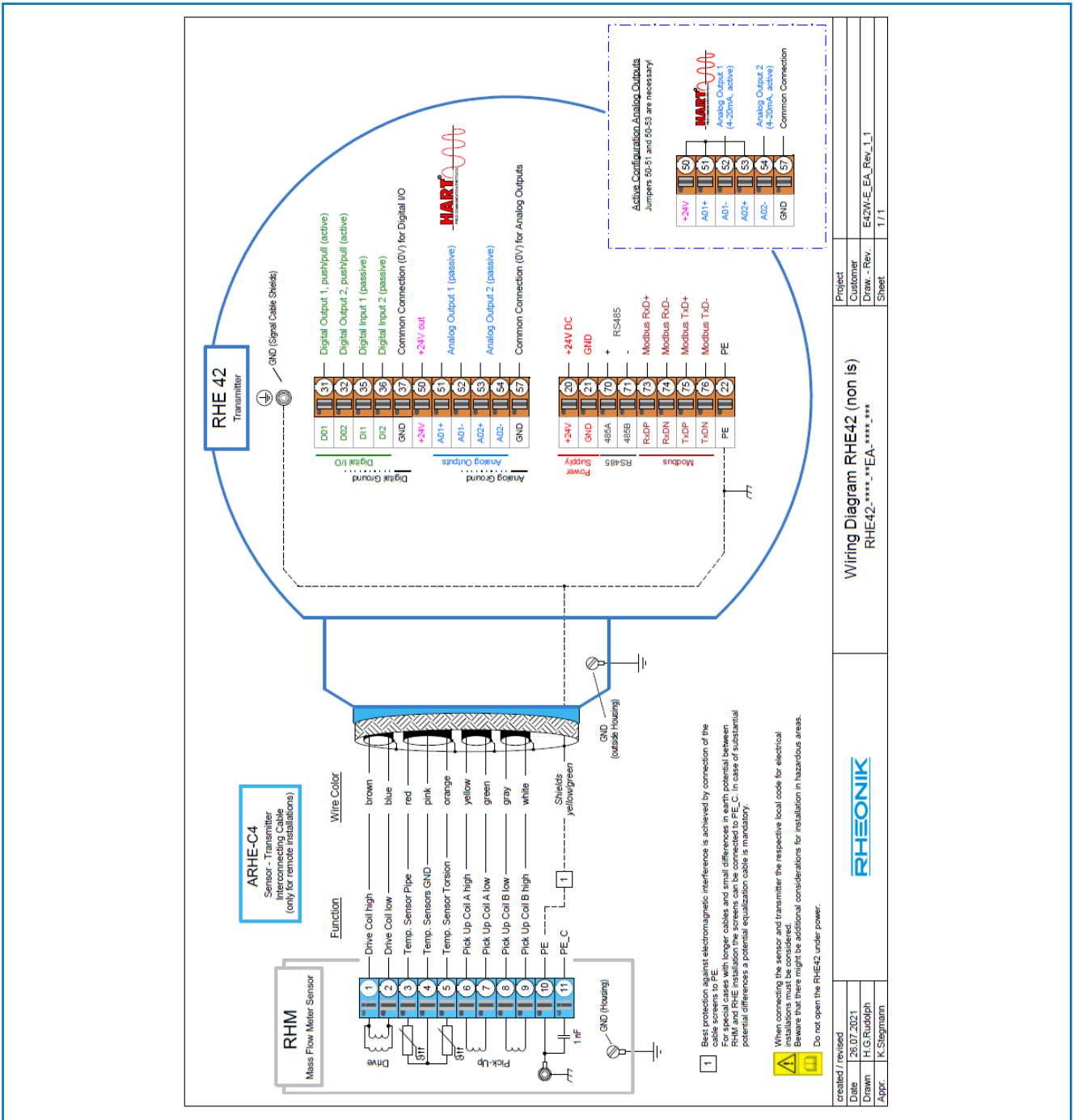

Fig. 28: Wiring diagrams for non-intrinsically safe variants

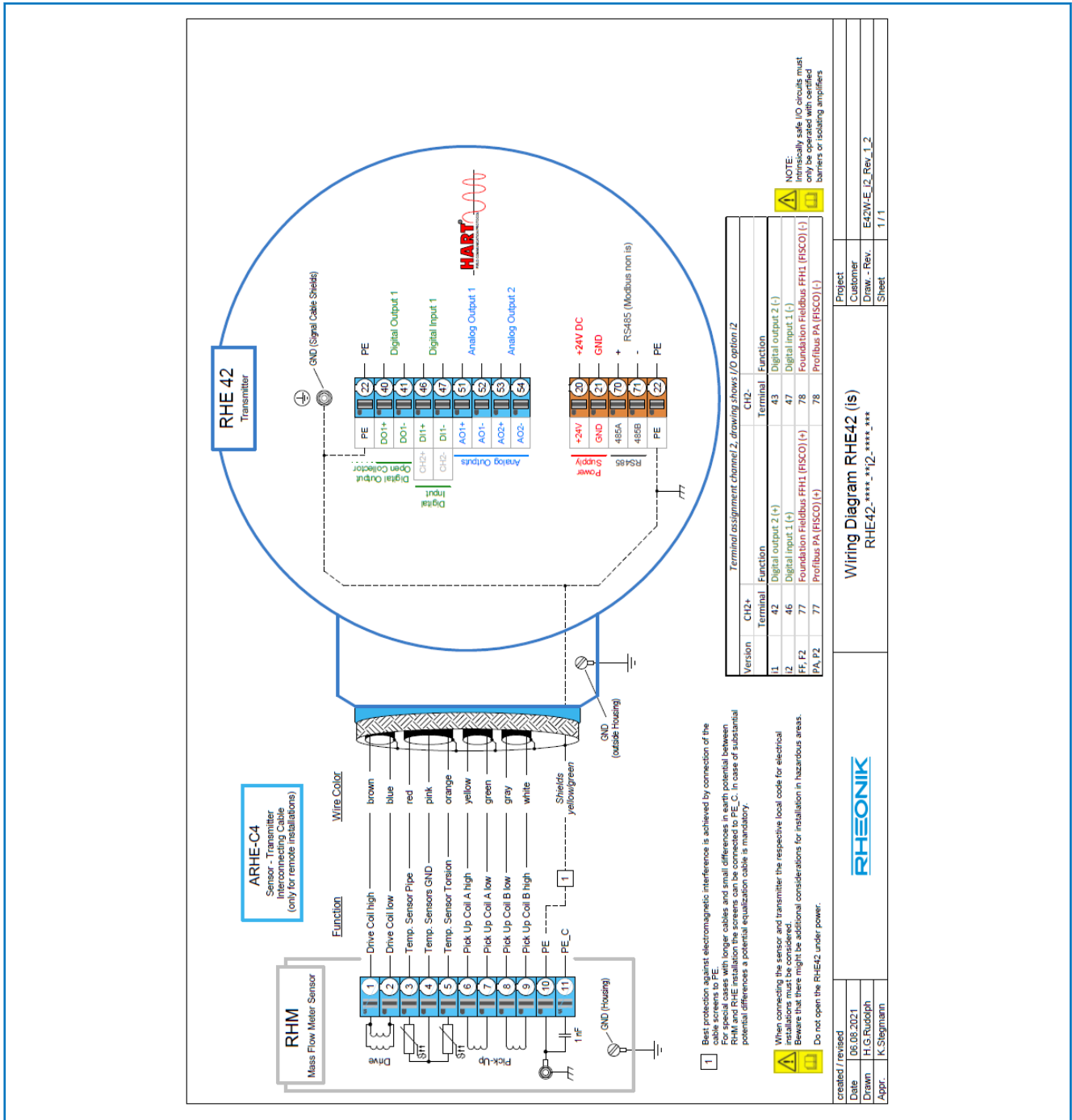

Fig. 29: Wiring diagrams for intrinsically safe variants



About Rheonik

Rheonik has but one single purpose: to design and manufacture the very best Coriolis meters available.

Our research and engineering resources are dedicated to finding new and better ways to provide cost effective accurate mass flow solutions that provide value to our customers. Our manufacturing group care for each and every meter we produce from raw materials all the way to shipping, and our service and support group are available to help you specify, integrate, start-up and maintain every Rheonik meter you have in service. Whether you own just one meter or have hundreds, you will never be just another customer to us. You are our valued business partner.

Need a specific configuration for your plant? Don't compromise with a "standard" product from elsewhere that will add extra cost to your installation. If we can't configure it from our extensive and versatile product range, our exclusive **AnyPipeFit Commitment** can have your flow sensor customized with any size/type of process connection and face to face dimension you need.

No matter what control system you use as the backbone in your enterprise, with our **AnyInterface Commitment**, you can be sure that connection and communication will not be a problem. Alongside a wide variety of discrete analog and digital signal connections, we can also provide just about any network/bus interface available (for example: HART, ProfibusDP, ProfiNet, EtherCAT, PowerLink, EtherNet/IP, CAN,) with our RHE 40 Series family of transmitters. Rheonik RHE 40 Series transmitters can connect to your system – no headache and no conversion needed.

Rheonik Messtechnik GmbH
Rudolf-Diesel-Straße 5
D-85235 Odelzhausen
Germany

Tel + 49 (0)8134 9341-0
info@rheonik.com

